

GA-5YASV-RH
Xeon® Processor Motherboard

USER'S MANUAL

Xeon® Processor Motherboard
Rev. 1001



* The WEEE marking on the product indicates this product must not be disposed of with user's other household waste and must be handed over to a designated collection point for the recycling of waste electrical and electronic equipment!!



* The WEEE marking applies only in European Union's member states.

Table of Content

Item Checklist	4
WARNING!	4
Chapter 1 Introduction	5
1.1 Features Summary	5
1.2 GA-5YASV-RH Motherboard Components	8
Chapter 2 Hardware Installation Process	10
2-1: Installing Processor and CPU Heat Sink	10
2-1-1: Installing CPU	10
2-1-2: Installing Cooling Fan	11
2-2: Install Memory Modules	12
2-3: Connect ribbon cables, cabinet wires, and power supply	14
2-3-1 : I/O Back Panel Introduction	14
2-4: Connectors Introduction	16
2-5: Jumper Setting	24
2-6: Block Diagram	33
Chapter 3 BIOS Setup	34
Main	36
Advanced Processor Options	39
Advanced	41
Memory Configuration	42
PCI Configuration	43
I/O Device Configuration	45
Advanced Chipset Control	49
Hardware Monitor	51
Security	53
Server	55
System Management	56
Console Redirection	57
Boot	61
Exit	62

Chapter 4 INTEL RAID BIOS Configuration	67
Chapter 5 Appendix	72

Item Checklist

- | | |
|---|---|
| <input checked="" type="checkbox"/> The GA-5YASV-RH motherboard | <input checked="" type="checkbox"/> Serial ATA cable x 6 |
| <input checked="" type="checkbox"/> IDE (ATA133) cable x 1 / Floppy cable x 1 | <input checked="" type="checkbox"/> I/O Shield Kit |
| <input checked="" type="checkbox"/> CD for motherboard driver & utility | <input checked="" type="checkbox"/> SATA Power cable x 3 |
| <input checked="" type="checkbox"/> USB cable x 1 | <input checked="" type="checkbox"/> Ga-5YASV-RH Quick Reference Guide |



WARNING!

Computer motherboards and expansion cards contain very delicate Integrated Circuit (IC) chips. To protect them against damage from static electricity, you should follow some precautions whenever you work on your computer.

1. Unplug your computer when working on the inside.
2. Use a grounded wrist strap before handling computer components. If you do not have one, touch both of your hands to a safely grounded object or to a metal object, such as the power supply case.
3. Hold components by the edges and try not touch the IC chips, leads or connectors, or other components.
4. Place components on a grounded antistatic pad or on the bag that came with the components whenever the components are separated from the system.
5. Ensure that the ATX power supply is switched off before you plug in or remove the ATX power connector on the motherboard.

Installing the motherboard to the chassis...

If the motherboard has mounting holes, but they don't line up with the holes on the base and there are no slots to attach the spacers, do not become alarmed you can still attach the spacers to the mounting holes. Just cut the bottom portion of the spacers (the spacer may be a little hard to cut off, so be careful of your hands). In this way you can still attach the motherboard to the base without worrying about short circuits. Sometimes you may need to use the plastic springs to isolate the screw from the motherboard PCB surface, because the circuit wire may be near by the hole. Be careful, don't let the screw contact any printed circuit write or parts on the PCB that are near the fixing hole, otherwise it may damage the board or cause board malfunctioning.

Chapter 1 Introduction

1.1 Features Summary

Form Factor	<ul style="list-style-type: none"> • 9.6" x 9.6" MATX form factor, 6 layers PCB.
CPU	<ul style="list-style-type: none"> • Supports single Intel® Xeon® processor • Intel Xeon® Quad-Core processor in LGA 775 socket • Supports 800/1066/1333MHz FSB
Chipset	<ul style="list-style-type: none"> • Intel® 3200 Chipset • Intel® ICH9R
Memory	<ul style="list-style-type: none"> • 4 x DDR2 DIMM sockets • Supports up to 8GB 667/800 memory • Dual Channel memory bus • ECC Unbuffered DDR2 667/800 • Supports 1GB, 2GB memory
I/O Control	<ul style="list-style-type: none"> • ITE IT8718F Super I/O
Expansion Slots	<ul style="list-style-type: none"> • Supports 2 PCI slots 32-Bit/33MHz (5V) • Supports 1 PCI-Express x8 slot • Supports 1 PCI-Express x8 slot (at x1 bandwidth)
SATA RAID Controller	<ul style="list-style-type: none"> • Built in Intel® ICH9R with Software RAID 0,1,10, 5 (Windows Only) • Optional LSI SW RAID 0/1/10 • Supports 6 SATA 3.0 Gb/s connectors
On-Board Graphic	<ul style="list-style-type: none"> • XGI Volari Z9s • 32MB DDR2
On-Board Peripherals	<ul style="list-style-type: none"> • 1 ATA 133 connector • 1 Floppyport supports 360K, 720K, 1.2M, 1.44M and 2.88M bytes. • 2 PS/2 connectors • 1 Parallel port supports Normal/EPP/ECP mode • 2 Serial port (COM, 1 by cable) • 6 x USB 2.0 (4 by cable) • 1 VGA connector • 2 x LAN RJ45 • 6 x SATA 3.0Gb/s connectors

GA-5YASV-RH Motherboard

Hardware Monitor	<ul style="list-style-type: none">• Enhanced features with CPU Vcore, 1.2V reference, VCC3 (3.3V) , VBAT3V, +5VSB, CPU Temperature, and System Temperature Values viewing• CPU/Power/System Fan Revolution Detect• CPU shutdown when overheat• System Voltage Detect
On-Board LAN	<ul style="list-style-type: none">• Intel® 82566DM & 82573LGbE controllers• Supports dual Gigabit LAN ports• I/O Acceleration Technology• Supports WOL
BIOS	<ul style="list-style-type: none">• Phoenix BIOS on 8Mb flash ROM
Special Features	<ul style="list-style-type: none">• Enhanced feature with GSMT Lite Utility
Additional Features	<ul style="list-style-type: none">• PS/2 Mouse wake up from S1 under Windows Operating System• External Modem wake up• Supports S1, S4, S5 under Windows Operating System• Wake on LAN (WOL)• Wake on Ring (WOR)• AC Recovery• Supports Console Redirection• Supports 4-pin Fan controller

1.2 GA-5YASV-RH Motherboard Components

- | | |
|--------------------------------|----------------------------------|
| 1. CPU | 22. Front fan cable connector |
| 2. Intel 3200 | 23. Rear fan cable connector |
| 3. Intel ICH9R | 24. Front Panle connector |
| 4. XGI Volari Z9s | 25. PCI_B Slot(32bit/33MHz) |
| 5. SAMSUNG DDR2 | 26. PCI_A Slot(32bit/33MHz) |
| 6. ITE IT8718F | 27. PCI-E x8 Slot |
| 7. Intel 82573LGbE | 28. PCI-E x8 Slot (x1 bandwidth) |
| 8. Intel 82566DM GbE | 29. DDR2A1 |
| 9. IDE cable connector | 30. DDR2A2 |
| 10. Floppy cable connector | 31. DDR2B1 |
| 11. COM2 connector | 32. DDR2B2 |
| 12. Front USB1 Connector | 33. RJ45 LAN/USB ports |
| 13. Front USB2 Connector | 34. VGA Port |
| 14. SATA0 Connector | 35. Parallel Port |
| 15. SATA1 Connector | 36. COM Port |
| 16. SATA2 Connector | 37. PS/2 Connectors |
| 17. SATA3 Connector | 38. Battery |
| 18. SATA4 Connector | 39. 24-pin ATX power connector |
| 19. SATA5 Connector | 40. 8-pin ATX power connector |
| 20. CPU fan cable connector | |
| 21. System fan cable connector | |

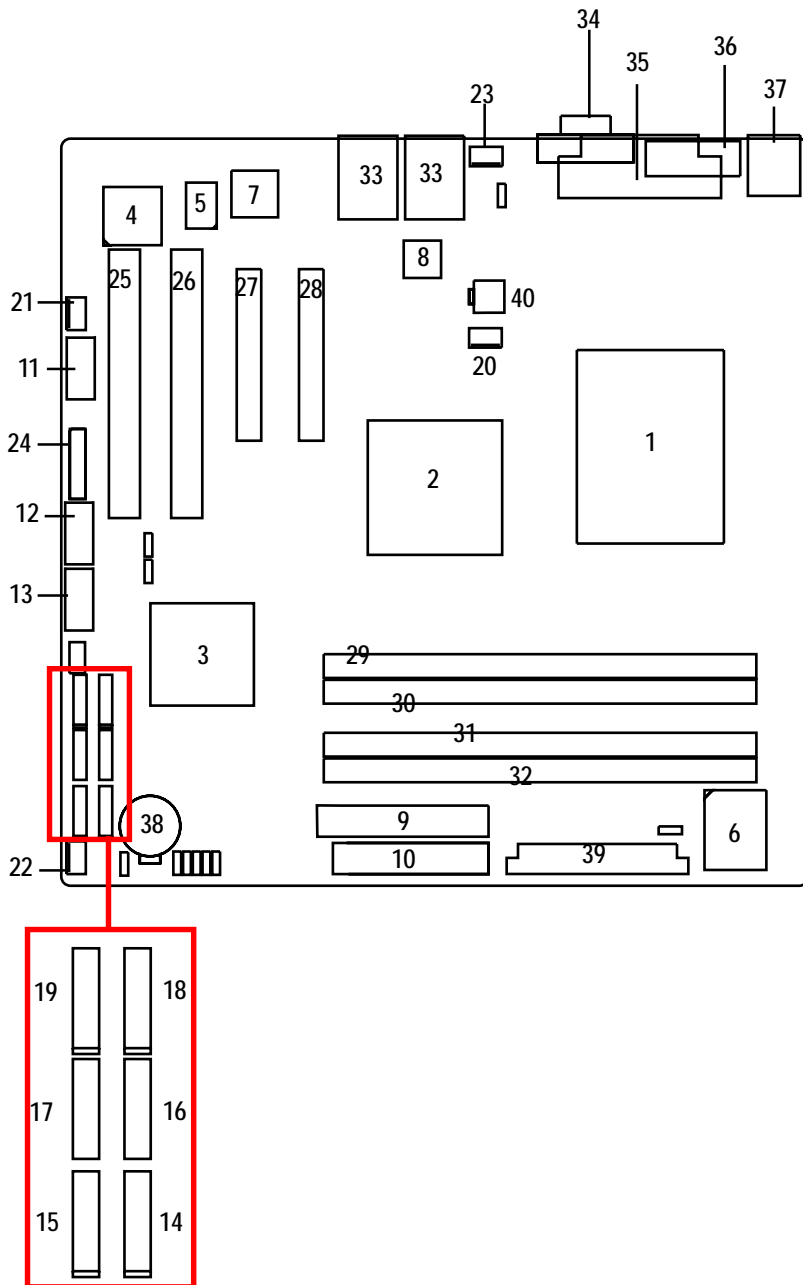

Chapter 2 Hardware Installation Process

2-1: Installing Processor and CPU Heat Sink



Before installing the processor and cooling fan, adhere to the following cautions:

1. The processor will overheat without the heatsink and/or fan, resulting in permanent irreparable damage.
2. Never force the processor into the socket.
3. Apply thermal grease on the processor before placing cooling fan.
4. Please make sure the CPU type is supported by the motherboard.
5. If you do not match the CPU socket Pin 1 and CPU cut edge well, it may damage the CPU. Please change the insert orientation.

2-1-1: Installing CPU

- Step 1 Raise the metal locking lever on the socket.
- Step 2 Remove the plastic covering on the CPU socket.
- Step 3 Lift the metal cover.
- Step 4 Insert the CPU with the correct orientation. The CPU only fits in one orientation.
- Step 5 Once the CPU is properly placed, please replace the metal cover and push the metal lever back into locked position.

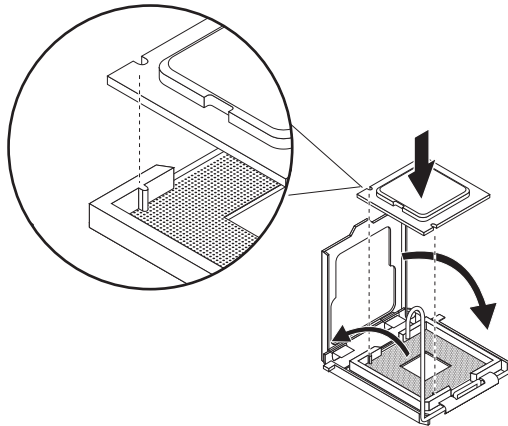

2-1-2: Installing Cooling Fan

- Step 1 Attach the heat sink clip to the processor socket.
- Step 2 Place the cooling fan on the heat sink.
- Step 3 Secure the cooling fan with screws.
- Step 4 Connect processor fan can cable to the processor fan connector

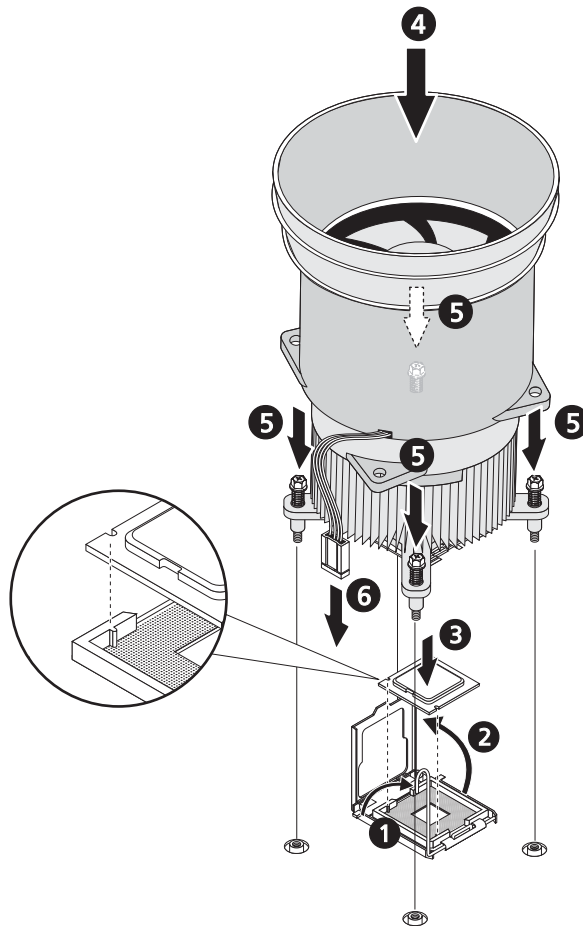

2-2: Install Memory Modules



Before installing the processor and heatsink, adhere to the following warning:
When DIMM LED is ON, do not install/remove DIMM from socket.

CAUTION

GA-5YASV-RH has 4 dual inline memory module (DIMM) sockets. It supports Dual Channels Technology. The BIOS will automatically detects memory type and size during system boot. For detail DIMM installation, please refer to the following instructions.

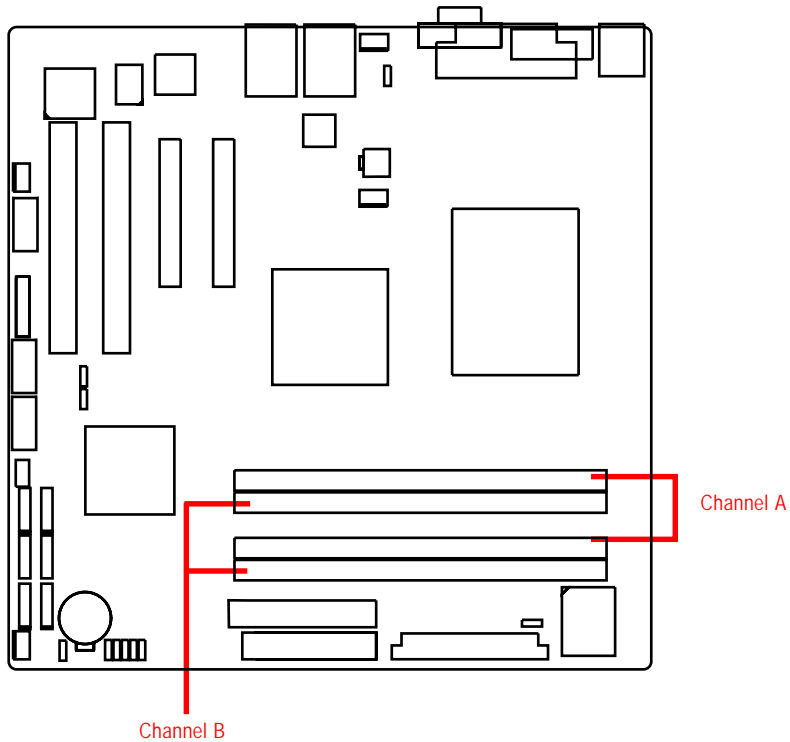
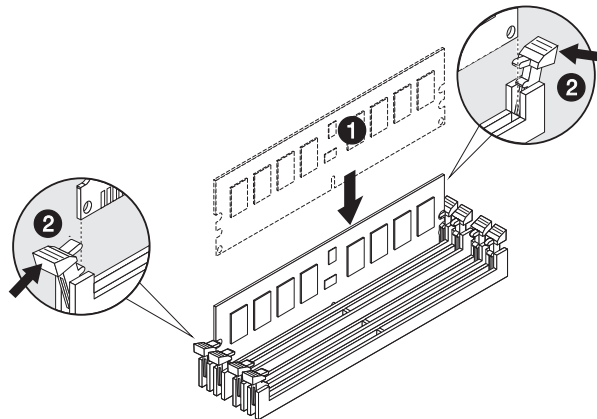

Table 1. Supported DIMM Module Type

Size	Organization	RAM Chips/DIMM
256MB	8MB x 8 x 4 bks	8
	16MB x 4 x 4bks	16
512MB	16MB x 8 x 4bks	8
	32MB x 4 x 4bks	16
1GB	32MB x 8 x 4bks	8
	64MB x 4 x 4bks	16

Installation Steps:

1. Unlock a DIMM socket by pressing the retaining clips outwards. Aling a DIMM on the socket such that the notch on the DIMM exactly match the notch in the socket.
2. Firmly insert the DIMM into the socket until the retaining clips snap back in place.
NOTE!! We recommended you to populate the same device size on each socket and the same DIMM size.
4. Reverse the installation steps if you want to remove the DIMM module.



2-3: Connect ribbon cables, cabinet wires, and power supply

2-3-1 : I/O Back Panel Introduction



❶ PS/2 Keyboard and PS/2 Mouse Connector

To install a PS/2 port keyboard and mouse, plug the mouse to the upper port (green) and the keyboard to the lower port (purple).

❷/❸/❹ Parallel Port / Serial Port / VGA Port

This connector supports 1 standard COM port and 1 Parallel port. Device like printer can be connected to Parallel port ; mouse and modem etc can be connected to Serial port.

❺/❻ LAN Ports / USB Ports

Before you connect your device(s) into USB connector(s), please make sure your device(s) such as USB keyboard, mouse, scanner, zip, speaker...etc. have a standard USB interface. Also make sure your OS supports USB controller. If your OS does not support USB controller, please contact OS vendor for possible patch or driver updated. For more information please contact your OS or device(s) vendors.

LAN LED Description

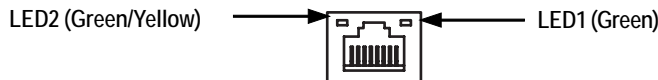

Name	Color	Condition	Description
LED1	Green	ON	LAN Link / no Access
	Green	BLINK	LAN Access
	-	OFF	Idle
LED2	-	OFF	10Mbps connection
	-	OFF	Port identification with 10 Mbps connection
	Green	ON	100Mbps connection
	Green	BLINK	Port identification with 100Mbps connection
	Yellow	ON	1Gbps connection
	Yellow	BLINK	Port identification with 1Gbps connection
	-	-	-

2-4: Connectors Introduction

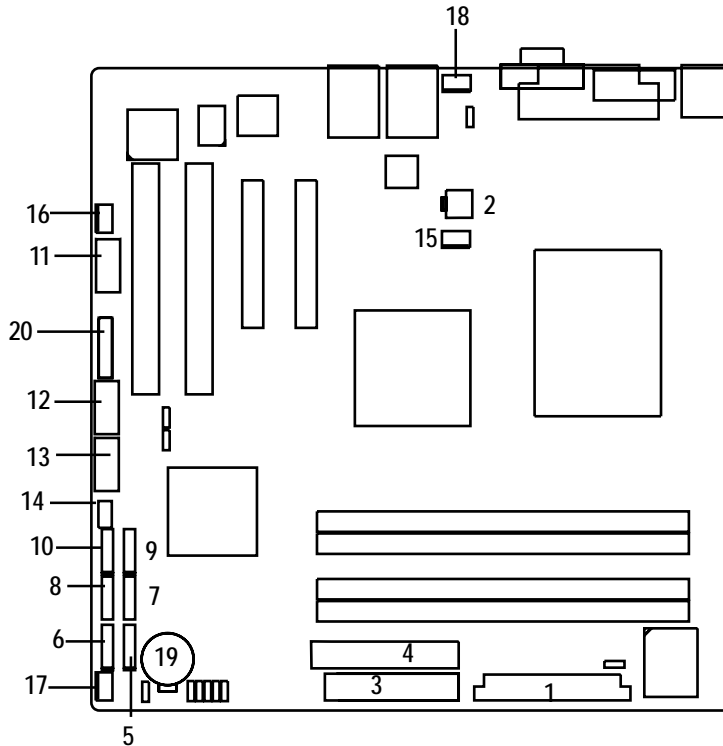

- | | |
|-----------------------------------|-------------------------------------|
| 1. ATX1 | 12. F_USB1 (USB cable connector) |
| 2. ATX2 | 13. F_USB2 (USB cable connector) |
| 3. IDE1 (IDE cable connector) | 14. SGPIO1 |
| 4. FDC1 (Floppy cable connector) | 15. CPU_FAN |
| 5. SATA 0 (SATA Connector) | 16. SYS_FAN |
| 6. SATA 1 (SATA cable connector) | 17. FRONT_FAN |
| 7. SATA 2 (SATA cable connector) | 18. REAR_FAN |
| 8. SATA 3 (SATA cable connector) | 19. F_Panel (Front Panel connector) |
| 9. SATA 4 (SATA cable connector) | 20. BAT1 (Battery) |
| 10. SATA 5 (SATA cable connector) | |
| 11. COM2 | |

1) ATX1 (24-pin ATX power connector)

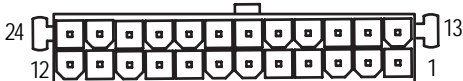
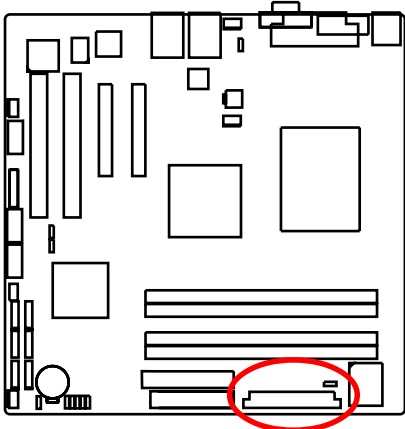

PIN No.	Definition
1	+3.3V
2	+3.3V
3	GND
4	+5V
5	GND
6	+5V
7	GND
8	POK
9	5VSB
10	+12V
11	+12V
12	+3.3V
13	+3.3V
14	-12V
15	GND
16	PSON
17	GND
18	GND
19	GND
20	-5V
21	+5V
22	+5V
23	+5V
24	GND

- AC power cord should only be connected to your power supply unit after ATX power cable and other related devices are firmly connected to the mainboard.

2) ATX2 (4-pin ATX power connector/12V)

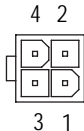
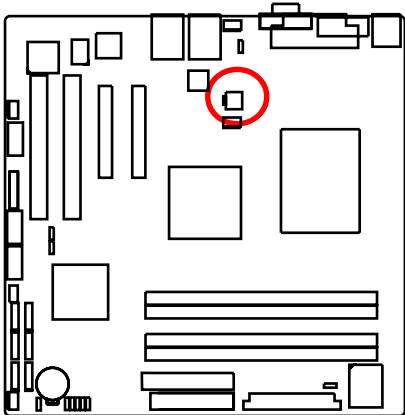

Pin No.	Definition
1	GND
2	GND
3	+12V
4	+12V

- This connector (ATX +12V) is used only for CPU Core Voltage.

3) IDE1 (IDE Connector)

Please connect first harddisk to IDE1. The red stripe of the ribbon cable must be the same side with the Pin1.

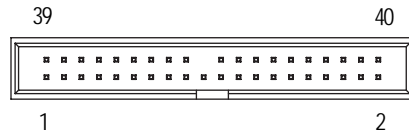
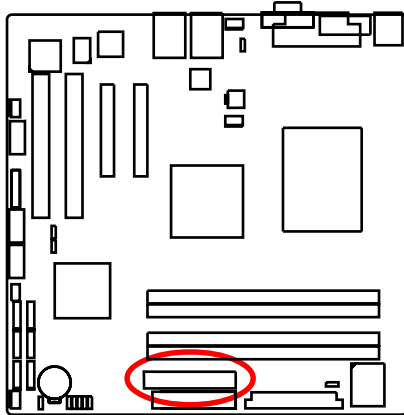

4) FDC1 (Floppy Connector)

Please connect the floppy drive ribbon cables to FDD. It supports 720K,1.2M,1.44M and 2.88Mbytes floppy disk types. The red stripe of the ribbon cable must be the same side with the Pin1.

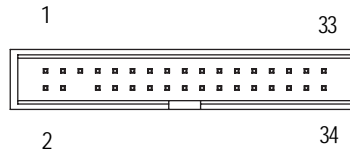
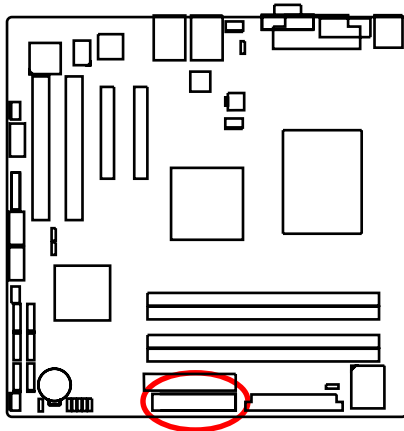

5/ 6/ 7/ 8/9/10) SATA 0-5 (Serial ATA cable connectors)

You can connect the Serial ATA device to this connector, it provides you high speed transfer rates (3.0Gb/sec).

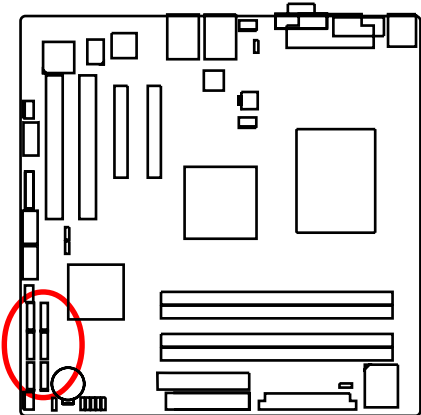

Pin No.	Definition
1	GND
2	TXP
3	TXN
4	GND
5	RXN
6	RXP
7	GND

11) COM2 (Serial port connector)

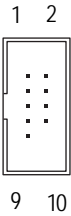
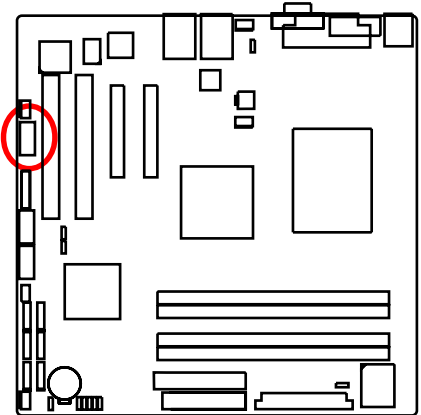

Pin No.	Definition
1	DCD-
2	SIN2
3	SOUT2
4	DTR2-
5	GND
6	DSR2-
7	RTS2-
8	CTS2-
9	RI2-
10	NC

12/ 13) F_USB1/2 (USB cable connectors)

Be careful with the polarity of the front USB connector. Check the pin assignment carefully while you connect the front USB cable, incorrect connection between the cable and connector will make the device unable to work or even damage it. For optional front USB cable, please contact your local dealer.

F_USB1

Pin No.	Definition
1	No Pin
2	NC
3	GND
4	GND
5	USB Dx+
6	USB Dy+
7	USB DX-
8	USB DY-
9	VCC
10	VCC

F_USB2

Pin No.	Definition
1	VCC
2	VCC
3	USB DX-
4	USB DY-
5	USB DX+
6	USB DY+
7	GND
8	GND
9	No Pin
10	NC

14) SGPIO1

SGPIO is stands for Serial General Purpose Input/Output which is a 4-signal (or 4-wire) bus used between a Host Bus Adapter (HBA) and a backplane. Out of the 4 signals, 3 are driven by the HBA and 1 is driven by the backplane. Typically, the HBA is a storage controller located inside a server, desktop, rack or workstation computer that interfaces with Hard disk drives (HDDs) to store and retrieve data.

SGPIO1

Pin No.	Definition
1	DATAOUT
2	NC
3	DATAOUT
4	GND
5	GND
6	LOAD
7	NC
8	CLOCK

15) UF1 (CPU fan cable connector)

Please note, a proper installation of the CPU cooler is essential to prevent the CPU from running under abnormal condition or damaged by overheating. The CPU fan connector supports Max. current up to 1A .

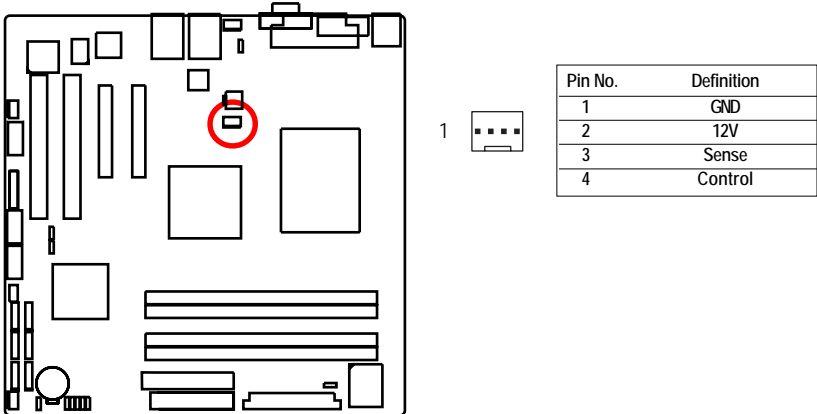

16/ 17/18) SYS_FAN/ERONT_FAN/REAR_FAN (System fan cable connectors)

These connector allows you to link with the cooling fan on the system case to lower the system temperature. These connectors are for system use only.

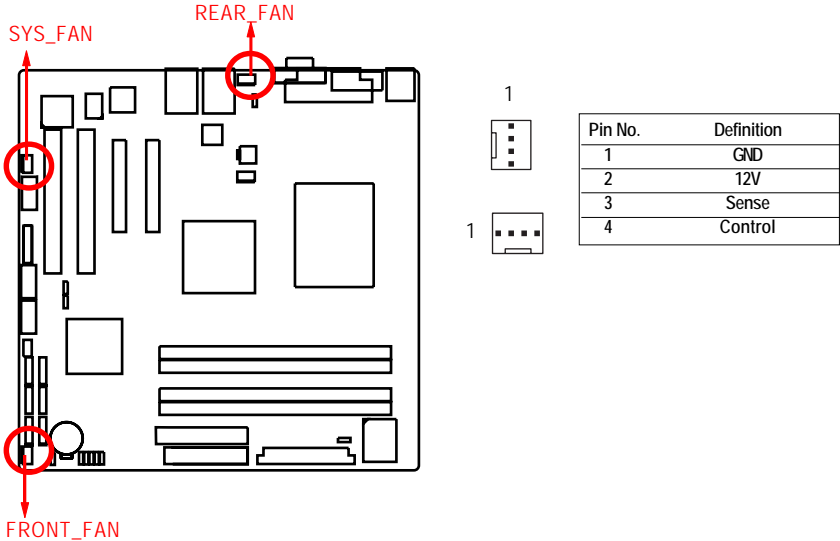

16) F_Panel (2X12 Pins Front Panel connector)

Please connect the power LED, PC speaker, reset switch and power switch of your chassis front panel to the F_PANEL connector according to the pin assignment above.

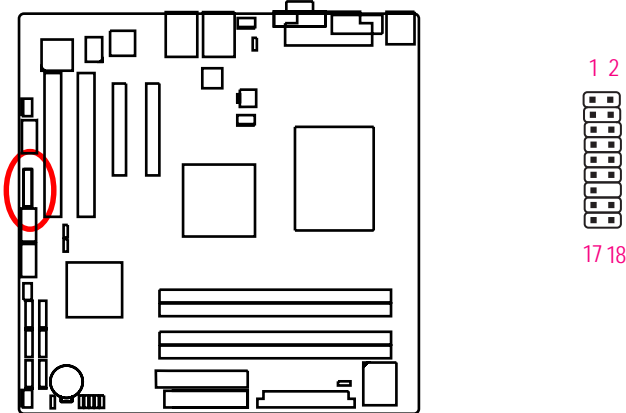

Pin No.	Signal Name	Description
1.	HDLED+	Hard Disk LED Signal anode (+)
2.	PWRLED+	Power LED Signal anode (+)
3.	HDLED-	Hard Disk LED Signal cathode(-)
4.	PWRLED-	Power LED Signal cathode(-)
5.	RESET	Reset Button
6.	PWRSW	Power Button Signal
7.	RESET	Reset Button
8.	PWRSW	Power Button Signal
9.	N/A	No connect
10.	N/A	No connect
11.	N/A	No connect
12.	N/A	No connect
13.	N/A	No connect
14.	N/C	Pin Removed
15.	LANA-	LAN access LED Signal cathode(-)
16.	N/A	No connect
17.	LANA+	LAN access LED Signal anode (+)
18.	N/A	No connect

17) Battery

If you want to erase CMOS...

1. Turn OFF the computer and unplug the power cord.
2. Remove the battery, wait for 30 second.
3. Re-install the battery.
4. Plug the power cord and turn ON the computer.

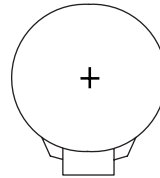
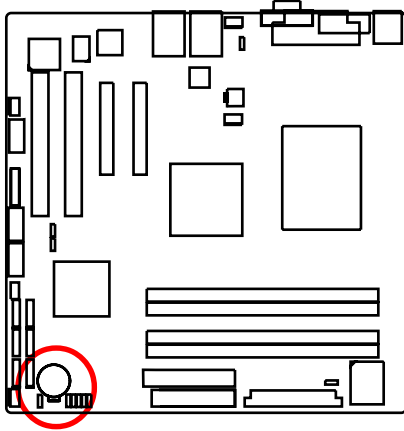

CAUTION

- ❖ Danger of explosion if battery is incorrectly replaced.
- ❖ Replace only with the same or equivalent type recommended by the manufacturer.
- ❖ Dispose of used batteries according to the manufacturer's instructions.

2-5: Jumper Setting

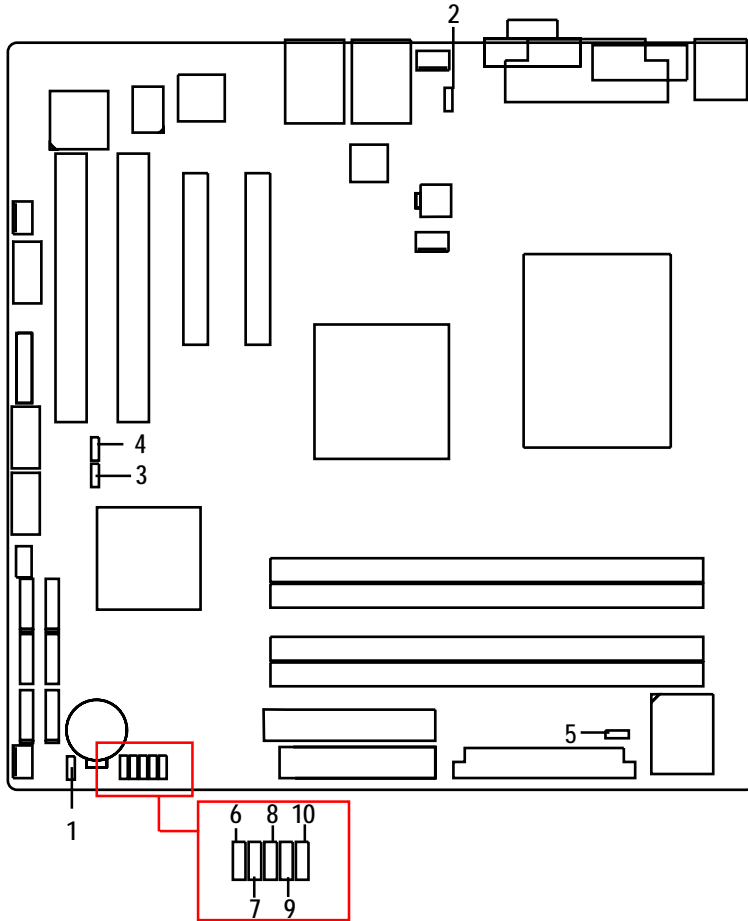



- | | |
|-------------|---------------|
| 1. CLR_CMOS | 6. MODEL_0 |
| 2. PWR_JP1 | 7. MODEL_1 |
| 3. PWR_JP2 | 8. MODEL_2 |
| 4. PWR_JP3 | 9. RECOVERY1 |
| 5. PWR_JP5 | 10. PASSWORD1 |

1) CLR_CMOS1 (Clear CMOS jumper)

You may clear the CMOS data to restore its default values by this jumper.

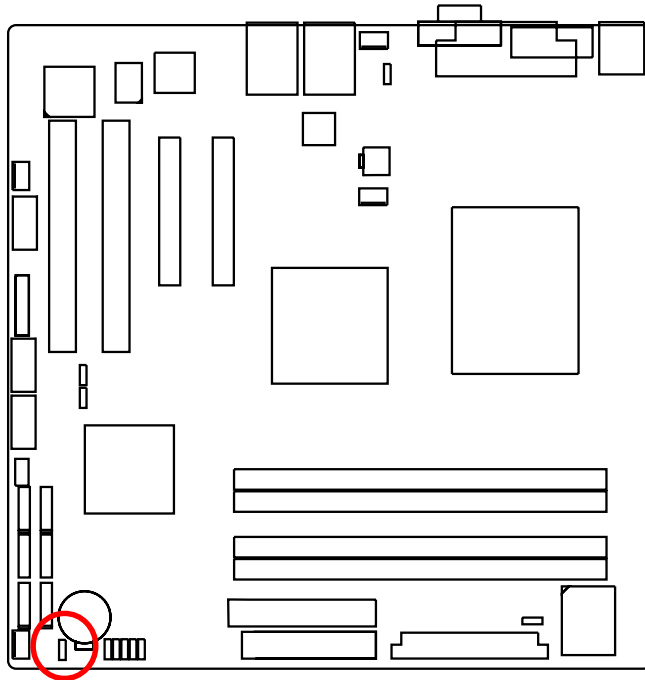
Default value doesn't include the "Shunter" to prevent from improper use this jumper. To clear CMOS, temporarily short 1-2 pin.





1  1-2 Close: Normal (Default setting)

1  2-3 Close: Clear CMOS

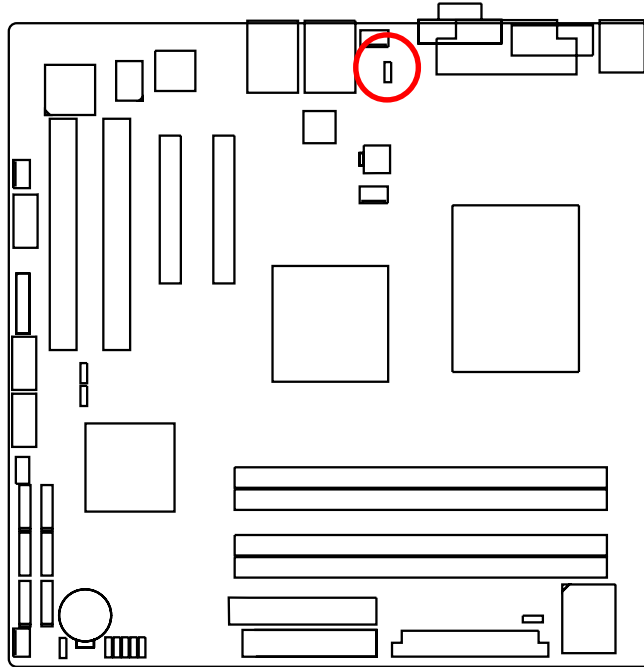
2) PWR_JP1 (USB power source selection jumper)





1  1-2 close: Rear USB powered when system shut down (Default setting)

1  2-3 close: Disable this function

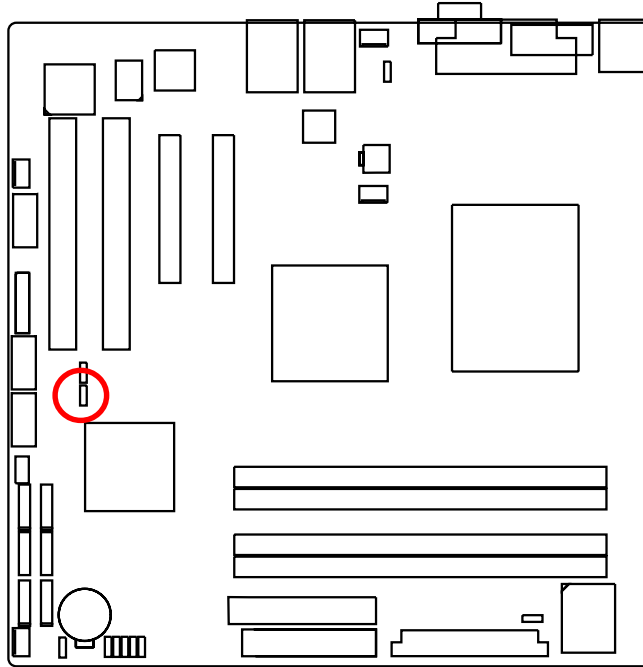

3) PWR_JP2 (USB2 power source selection jumper)



- 1  1-2 close: Front USB2 powered when system shut down. (Default setting)
- 1  2-3 close: Disable this function.

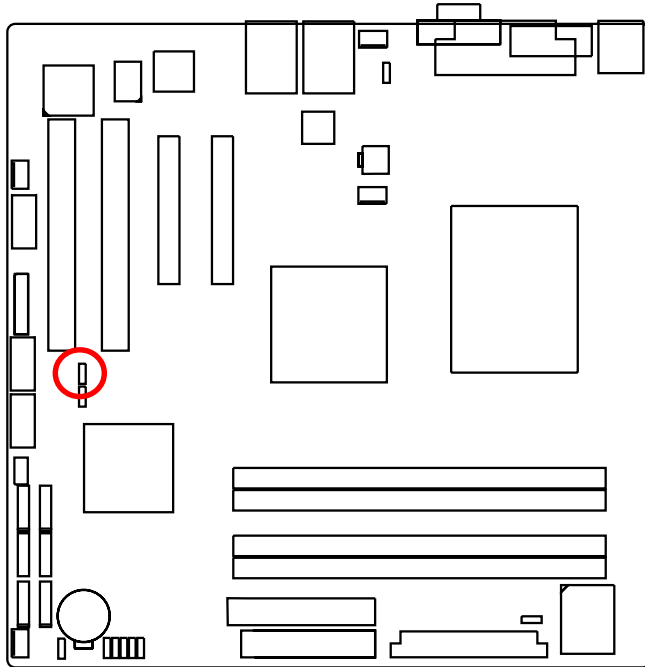

4) PWR_JP3 (USB1 power source selection jumper)





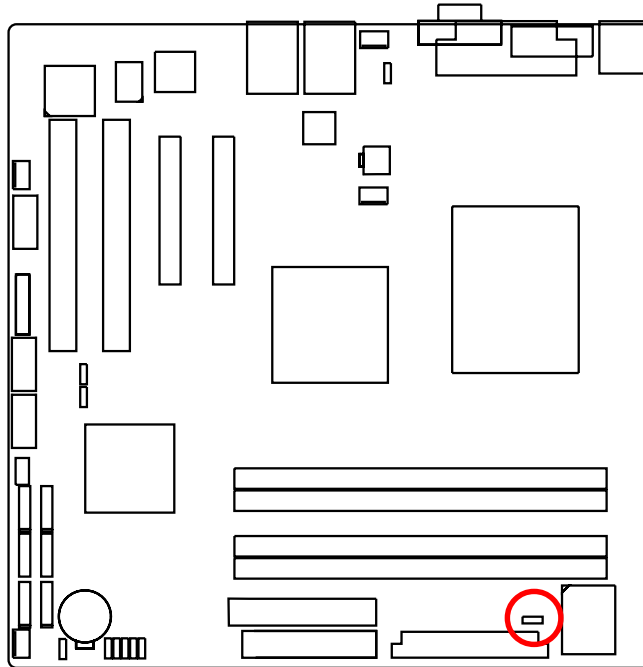

- 1  1-2 close: Front USB1 powered when system shut down. (Default setting)
- 1  2-3 close: Disable this function.

5) PWR_JP5 (PS2 Keyboard/Mouse power source selection jumper)

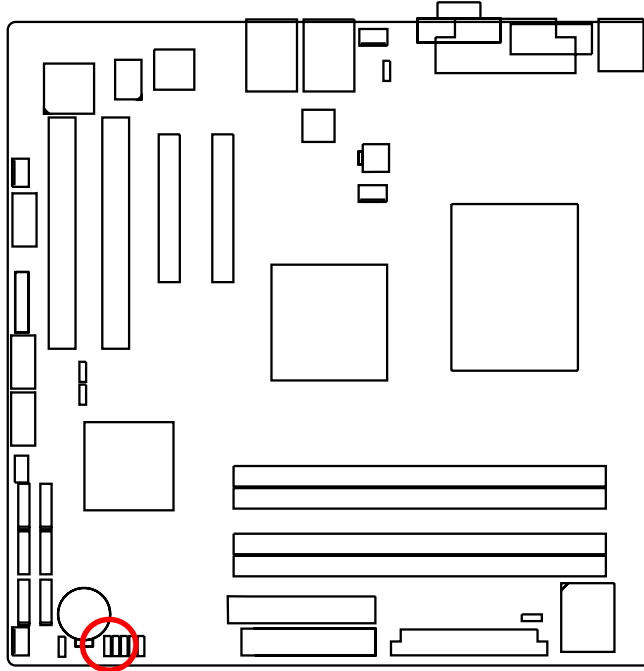



- 1  1-2 close: Keyboard/mouse powered when system shut down. (Default setting)
- 1  2-3 close: Disable this function.



- 1  Model_0 default setting: 1-2 close
- 1  Model_1 default setting: 2-3 close
- 1  Model_2 default setting: 2-3 close

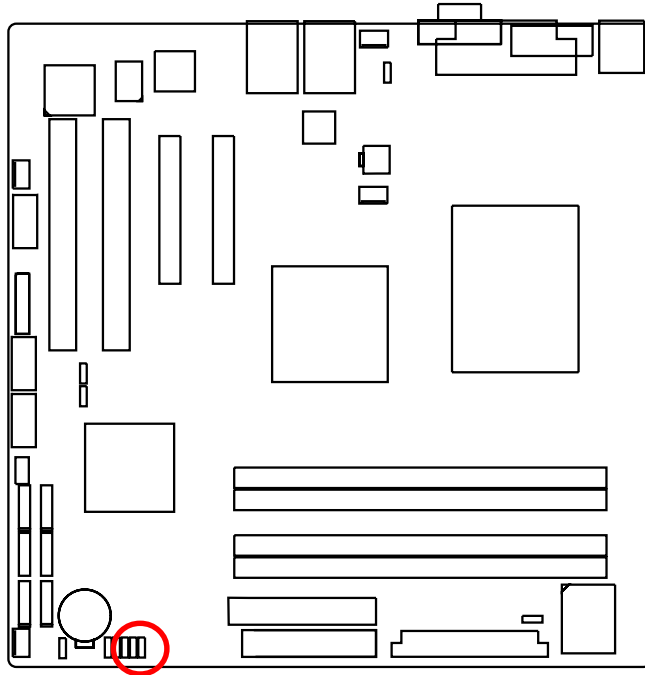

9) RECOVERY1 (BIOS recovery jumper)

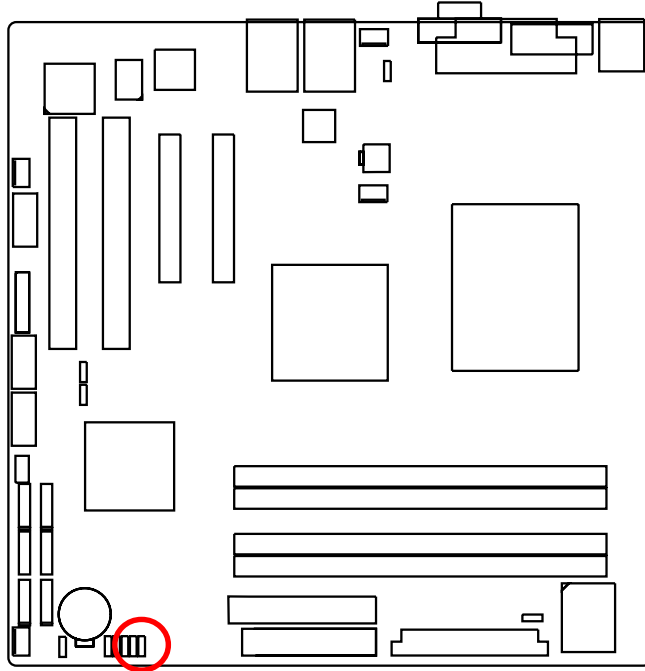

- 1  1-2 Close: Enable BIOS Recovery function.
- 1  2-3 Close: Normal (Default setting)

10) PASSWORD1 (Skip password jumper)



- 1  1-2 Close: Skip Supervisor Password in BIOS setup menu
- 1  2-3 Close: Normal (Default setting)

2-6: Block Diagram

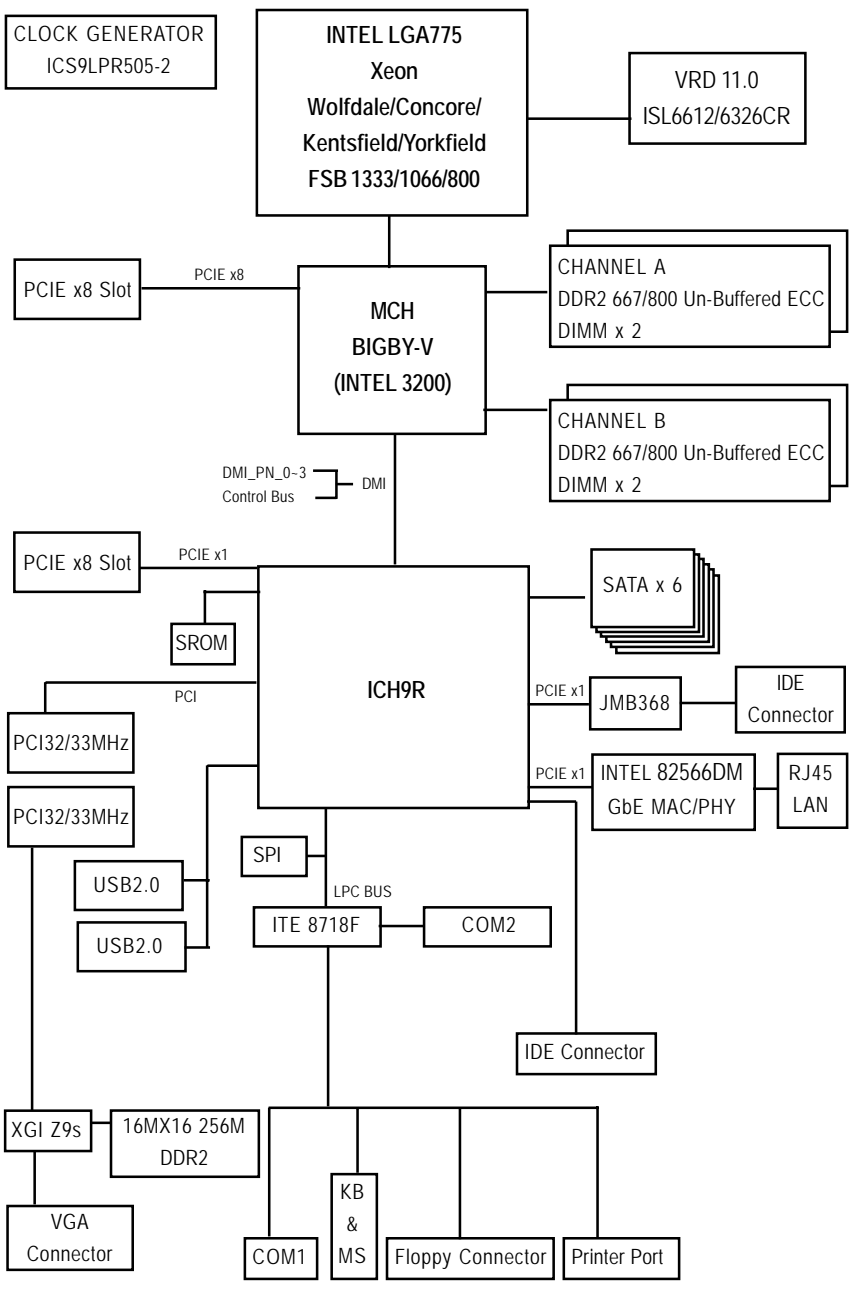

Chapter 3 BIOS Setup

BIOS Setup is an overview of the BIOS Setup Program. The program that allows users to modify the basic system configuration. This type of information is stored in battery-backed CMOS RAM so that it retains the Setup information when the power is turned off.

ENTERING SETUP

Power ON the computer and press <F2> immediately will allow you to enter Setup.

CONTROL KEYS

<↑>	Move to previous item
<↓>	Move to next item
<←>	Move to the item in the left hand
<→>	Move to the item in the right hand
<Esc>	Main Menu - Quit and not save changes into CMOS Status Page Setup Menu and Option Page Setup Menu - Exit current page and return to Main Menu
<+/PgUp>	Increase the numeric value or make changes
<-/PgDn>	Decrease the numeric value or make changes
<F1>	General help, only for Status Page Setup Menu and Option Page Setup Menu
<F2>	Reserved
<F3>	Reserved
<F4>	Reserved
<F6>	Reserved
<F7>	Reserved
<F8>	Reserved
<F9>	Load the Optimized Defaults
<F10>	Save all the CMOS changes, only for Main Menu

GETTINGHELP

Main Menu

The on-line description of the highlighted setup function is displayed at the bottom of the screen.

Status Page Setup Menu / Option Page Setup Menu

Press F1 to pop up a small help window that describes the appropriate keys to use and the possible selections for the highlighted item. To exit the Help Window press <Esc>.

- **Main**
This setup page includes all the items in standard compatible BIOS.
- **Advanced**
This setup page includes all the items of AMI special enhanced features.
(ex: Auto detect fan and temperature status, automatically configure hard disk parameters.)
- **Security**
Change, set, or disable password. It allows you to limit access the system and setup.
- **Server**
Server additional features enabled/disabled setup menus.
- **Boot**
This setup page include all the items of first boot function features.
- **Exit**
There are five options in this selection: Exit Saving Changes, Exit Discarding Changes, Load Optimal Defaults, Load Failsafe Defaults, and Discard Changes.

Main

Once you enter Phoenix BIOS Setup Utility, the Main Menu (Figure 1) will appear on the screen. Use arrow keys to select among the items and press <Enter> to accept or enter the sub-menu.

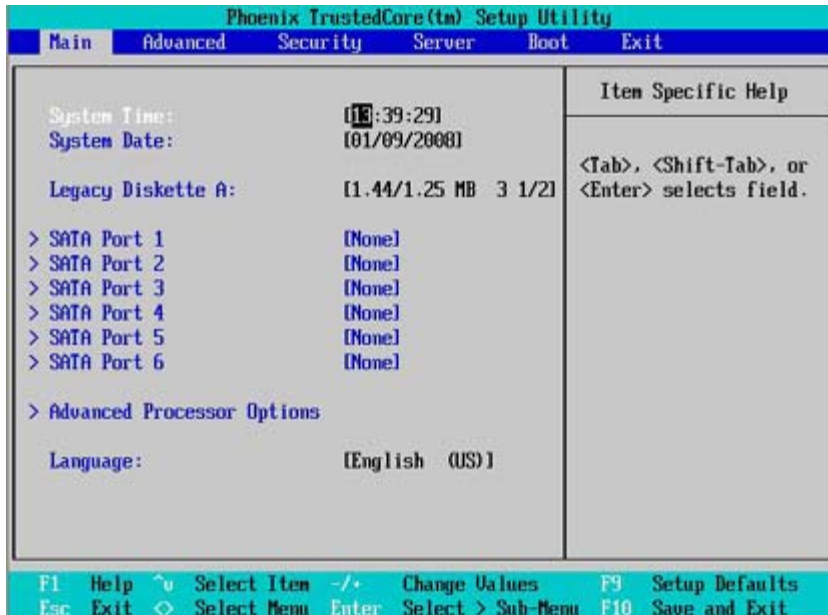

Figure 1: Main

☞ System Time

The time is calculated based on the 24-hour military time clock. Set the System Time (HH:MM:SS)

☞ System Date

Set the System Date. Note that the "Day" automatically changed after you set the date. (Weekend: DD: MM: YY) (YY: 1099-2099)

☞ Legacy Diskette A

This category identifies the type of floppy disk drive A that has been installed in the computer.

- ▶▶ Disabled Disable this device.
- ▶▶ 360KB, 5^{1/4} in. 3^{1/2} inch AT-type high-density drive; 360K byte capacity
- ▶▶ 1.2MB, 3^{1/2} in. 3^{1/2} inch AT-type high-density drive; 1.2M byte capacity
- ▶▶ 720K, 3^{1/2} in. 3^{1/2} inch double-sided drive; 720K byte capacity
- ▶▶ 1.44M, 3^{1/2} in. 3^{1/2} inch double-sided drive; 1.44M byte capacity.
- ▶▶ 2.88M, 3^{1/2} in. 3^{1/2} inch double-sided drive; 2.88M byte capacity.

Note: The 1.25MB, 3^{1/2} reference a 1024 byte/sector Japanese media format. The 1.25MB, 3^{1/2} diskette requires 3-Mode floppy-disk drive.

☞ SATA Port 1/2/3/4/5/6

The category identifies the types of hard disk from drive 1 to 6 that has been installed in the computer. There are two types: auto type, and manual type. Manual type is user-definable; Auto type which will automatically detect HDD type.

Note that the specifications of your drive must match with the drive table. The hard disk will not work properly if you enter improper information for this category.

If you select User Type, related information will be asked to enter to the following items. Enter the information directly from the keyboard and press <Enter>. Such information should be provided in the documentation from your hard disk vendor or the system manufacturer.

» **TYPE**

1-39: Predefined types.

Users: Set parameters by User.

Auto: Set parameters automatically. (Default Vaules)

CD-ROM: Use for ATAPI CD-ROM drives or double click [Auto] to set all HDD parameters automatically.

ATAPI Removable: Removable disk drive is installed here.

» **Multi-Sector Transfers**

This field displays the information of Multi-Sector Transfer Mode.

Disabled: The data transfer from and to the device occurs one sector at a time.

Auto: The data transfer from and to the device occurs multiple sectors at a time if the device supports it.

» **LBA Mode**

This field shows if the device type in the specific IDE channel support LBA Mode.

» **32-Bit I/O**

Enable this function to max imize the IDE data transfer rate.

» **Transfer Mode**

This field shows the information of Teansfer Mode.

» **Ultra DMA Mode**

This filed displays the DMA mode of the device in the specific IDE channel.

 **Language**

This category allows user to select preferred language.

» Options English, Francais, Deutsch, Espanol, Italiano.

Advanced Processor Options

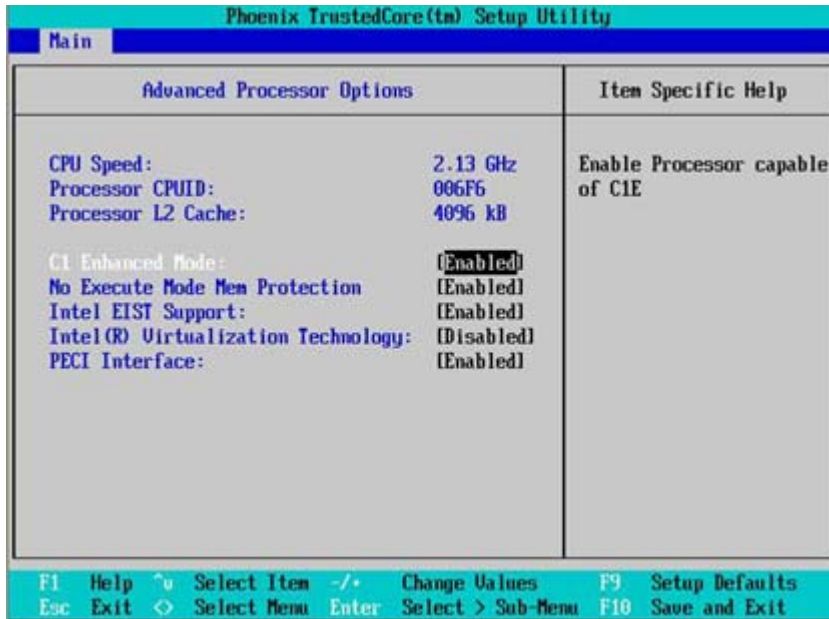

Figure 1-1: Advanced Processor Option

Advanced Processor Option

This category includes the information of CPU Speed, Processor CPUID, and Processor L2 Cache. Setup menu for C1 Enhanced Mode, No Execute Mode Memory Protection, Intel EIST Support, Intel Virtualization Technology, and PECC Interface.

C1 Enhanced Mode

With enabling C1 Enhanced Mode, all local processors in the physical processor have entered the C1 state, the processor will reduce the core clock frequency to system bus ratio and VID.

- ▶▶ Enabled Enabled C1 Enhanced Mode. (Default setting)
- ▶▶ Disabled Disables C1 Enhanced Mode.

☞ **No Execute Mode Mem. Protection**

- ▶▶ Enabled Enable No Execute Mode Memory Protection function. (Default setting)
- ▶▶ Disabled Disables No Execute Mode Memory Protection function.

☞ **Intel EIST Support**

Select the Power Management desired:

- ▶▶ Enabled C states and GV1/GV3 are enabled.
- ▶▶ C States Only GV1/GV3 are disabled.
- ▶▶ GV1/GV3 Only C states are disabled.
- ▶▶ Disabled C states and GV1/GV3 are disabled. (Default setting)

☞ **Intel (R) Virtualization Technology**

Intel(R) Virtualization Technology will allow a platform to run multiple operating systems and applications in independent partitions. With virtualization, one computer system can function as multiple "virtual" systems. With processor and I/O enhancements to Intel's various platforms, Intel Virtualization Technology can improve the performance and robustness of today's software-only virtual machine solutions.

- ▶▶ Enabled Enable Intel Virtualization Technology.
- ▶▶ Disabled Disable this function. (Default setting)

☞ **PECI Interface**

The Platform Environmental Control Interface (PECI Interface) is designed specifically to convey system management information from the processor. It is a proprietary single wire bus between the processor and the chipset or other health monitoring device. Data from the Digital Thermal Sensors are processed and stored in a processor register (MSR) which is queried through the Platform Environment Control Interface (PECI).

- ▶▶ Enabled Enable PECI Interface. (Default setting)
- ▶▶ Disabled Disable this function.

Advanced

About This Section: Advanced

With this section, allowing user to configure your system for basic operation. User can change the processor options, chipset configuration, PCI configuration and chipset control.

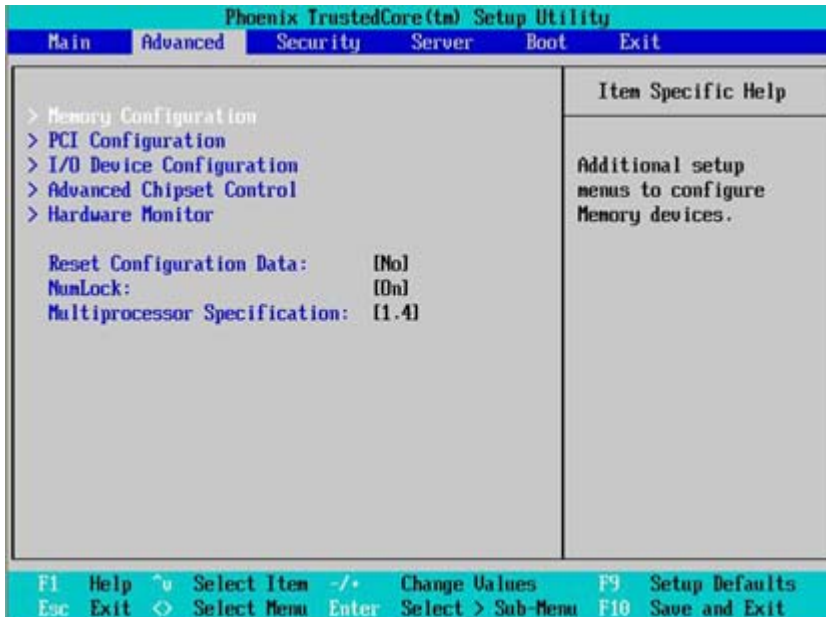

Figure 2: Advanced

Memory Configuration

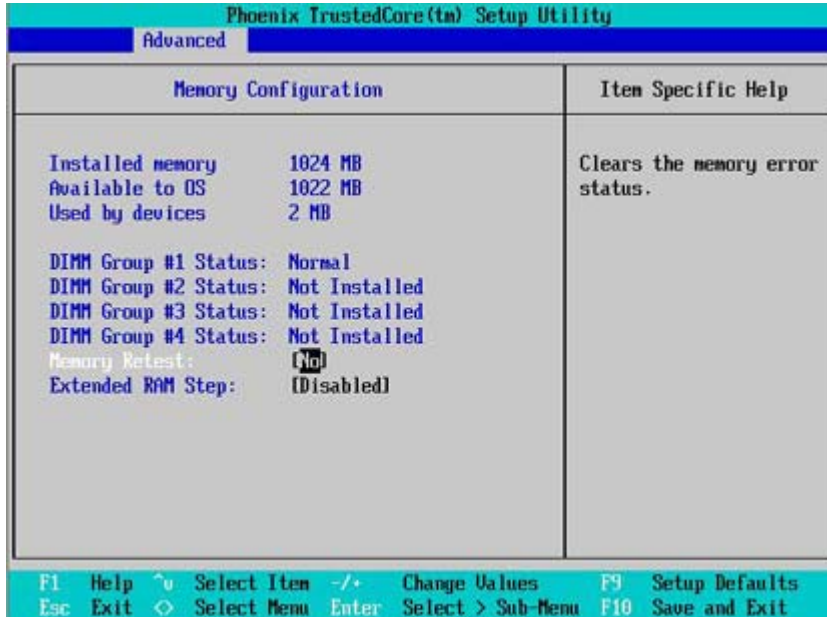

Figure 2-1: Memory Configuration

☞ Installed Memory/Available to OS/Used by devices/DIMM Group 1,2,3,4 Status

This category is display-only which is determined by POST (Power On Self Test) of the BIOS.

☞ Memory Reset

- ▶▶ Yes Select 'Yes', system will clear the memory error status. Save the changes and restart system. After rebooting system, the Memory Reset item will set to 'No' automatically.
- ▶▶ No Disable this function. (Default setting)

☞ Extend RAM Step

- ▶▶ Enabled Enable test extended memory process.
- ▶▶ Disabled Disable this function. (Default setting)

PCI Configuration

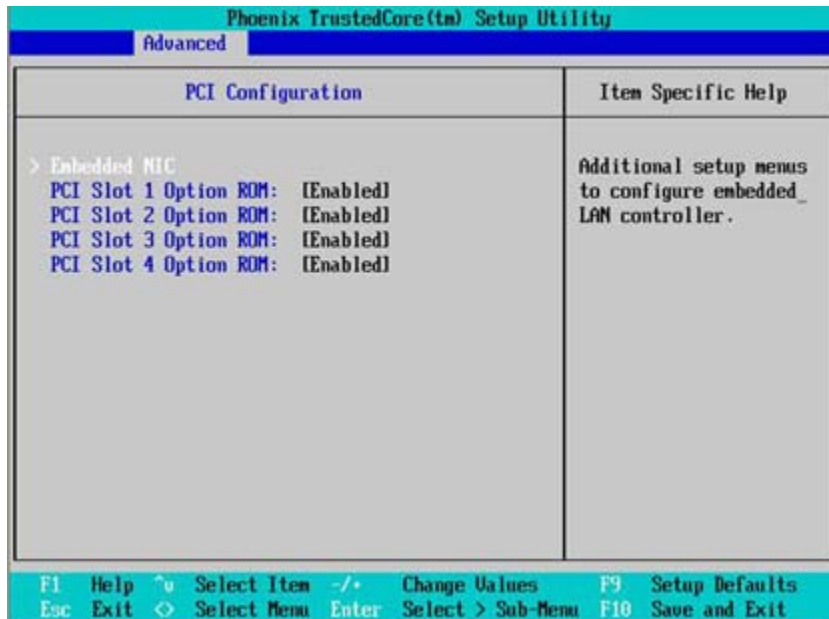

Figure 2-2: PCI Configuration

↳ Embedded NIC

▶ Onboard LAN1 Control

- ▶▶ Enabled Enable onboard LAN device. (Default setting)
- ▶▶ Disabled Disable this function.

▶ LAN1 Option ROM Scan

- ▶▶ Enabled Enabling this item to initialize device expansion ROM. (Default setting)
- ▶▶ Disabled Disable this function.

☞ PCI Slot 1/2/3/4 Option ROM

- ▶▶ Enabled Enableing this item to initialize device expansion ROM.
(Default setting)
- ▶▶ Disabled Disable this function.

I/O Device Configuration

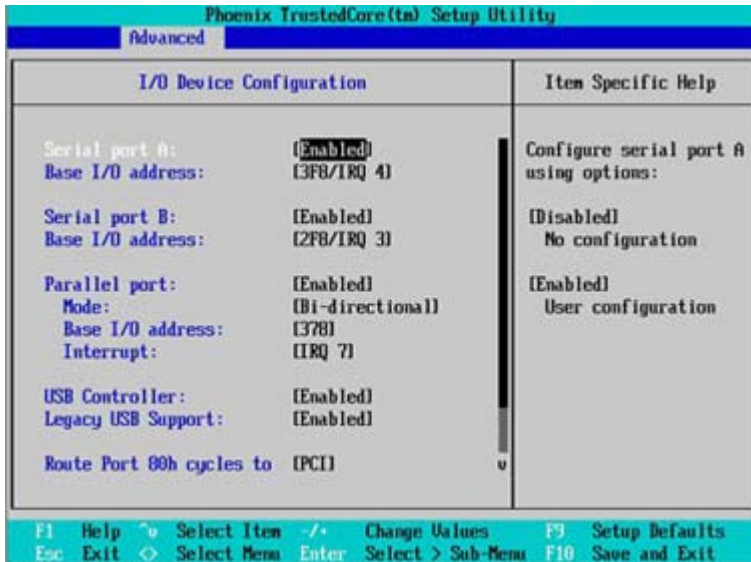
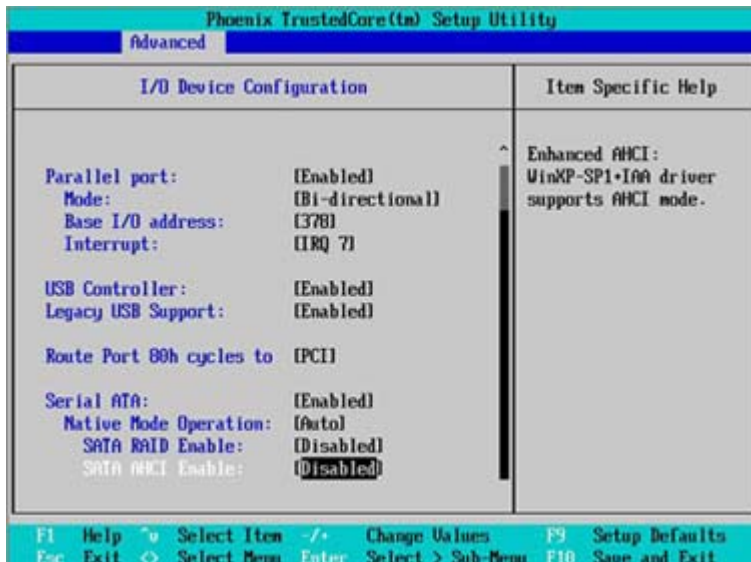

Figure 2-3: I/O Device Configuration



☞ **Serial Port A**

This allows users to configure serial port A by using this option.

- ▶▶ Enabled Enable the configuration (Default setting)
- ▶▶ Disabled Disable the configuration.

▶ **Base I/O Address/IRQ**

- ▶▶ 3F8/IRQ4 Set base IO address to 3F8 and IRQ to IRQ4. (Default setting)
- ▶▶ 2F8/IRQ3 Set base IO address to 2F8 and IRQ to IRQ3.
- ▶▶ 3E8/IRQ4 Set base IO address to 3E8 and IRQ to IRQ4.
- ▶▶ 2E8/IRQ3 Set base IO address to 2E8 and IRQ to IRQ3.

☞ **Serial Port B**

This allows users to configure serial port B by using this option.

- ▶▶ Enabled Enable the configuration. (Default setting)
- ▶▶ Disabled Disable the configuration.

▶ **Base I/O Address/IRQ**

- ▶▶ 3F8/IRQ4 Set base IO address to 3F8 and IRQ to IRQ4.
- ▶▶ 2F8/IRQ3 Set base IO address to 2F8 and IRQ to IRQ3. (Default setting)
- ▶▶ 3E8/IRQ4 Set base IO address to 3E8 and IRQ to IRQ4.
- ▶▶ 2E8/IRQ3 Set base IO address to 2E8 and IRQ to IRQ3.

☞ **Parallel Port**

This allows users to configure parallel port by using this option.

- ▶▶ Enabled Enable the configuration.
- ▶▶ Disabled Disable the configuration. (Default setting)

▶ **Mode**

This option allows user to set Parallel Port transfer mode.

- ▶▶ Bi-directional Use this setting to support bi-directional transfers on the parallel port. (Default setting)
- ▶▶ EPP Using Parallel port as Enhanced Parallel Port.
- ▶▶ ECP Using Parallel port as Extended Capabilities Port.

▶ **Base I/O Address**

- ▶▶ 378 Set IO address to 378. (Default setting)
- ▶▶ 278 Set IO address to 278.

▶ **Interrupt**

- ▶▶ IRQ5 Set Interrupt as IRQ5.
- ▶▶ IRQ7 Set Interrupt as IRQ7. (Default setting)

🔗 **USB Controller**

This item allows users to enable or disable the USB device by setting item to the desired value.

- ▶▶ Enabled Enable USB controller. (Default setting)
- ▶▶ Disabled Disbale this function.

🔗 **Legacy USB Support**

This option allows user to function support for legacy USB.

- ▶▶ Enabled Enables support for legacy USB (Default setting)
- ▶▶ Disabled Disables support for legacy USB.

🔗 **Route Port 80h cycles to**

Set route port 80h cycles to either PCI or LPC bus.

- ▶▶ PCI Set Route Port 80h I/O cycles to the PCI bus. (Default setting)
- ▶▶ LPC Set Route Port 80h I/O cycles to the LPC bus.

Serial ATA

- ▶▶ Enabled Enables on-board serial ATA function. (Default setting)
- ▶▶ Disabled Disables on-board serial ATA function.

▶ Native Mode Operation

This option allows user to set the native mode for Serial ATA function.

- ▶▶ Auto Auto detected. (Default setting)
- ▶▶ Serial ATA Set Native mode to Serial ATA.

▶ SATA RAID Enable

- ▶▶ Enabled Enabled SATA RAID function.
- ▶▶ Disabled Disable this function. (Default setting)

▶ SATA AHCI Enable

- ▶▶ Enabled Set this item to enable SATA AHCI function for WinXP-SP1+IAA driver supports AHCI mode.
- ▶▶ Disabled Disabled this function. (Default setting)

Advanced Chipset Control

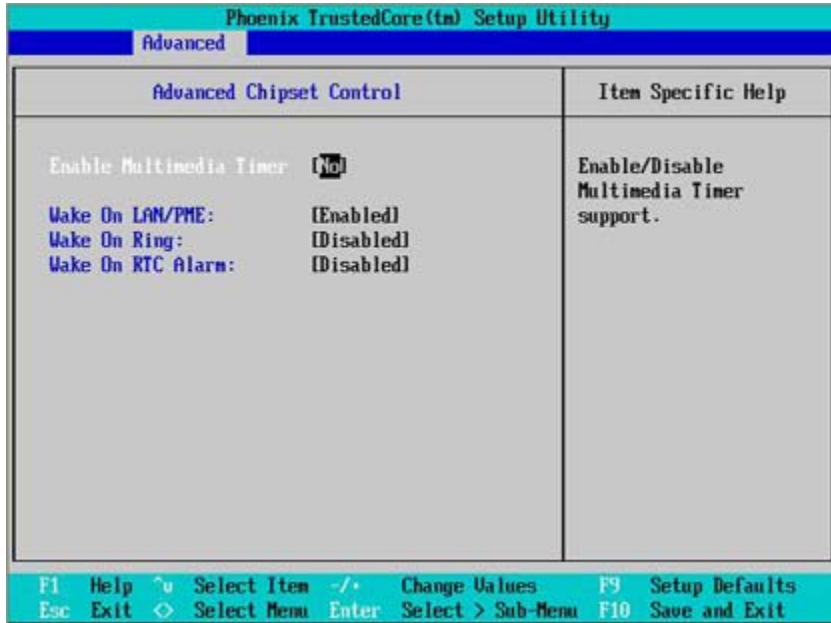

Figure 2-4: Advanced Chipset Control

☞ Enable Multimedia Timer

- ▶▶ Enabled Enable Multimedia Timer support.
- ▶▶ Disabled Disable this function. (Default setting)

☞ Wake On LAN / PME

This option allow user to determine the action of the system when a LAN/PME wake up event occurs.

- ▶▶ Enabled Enable Wake On LAN/PME. (Default setting)
- ▶▶ Disabled Disable this function.

Note: This item must enabled if you're running under Windows operating system.

☞ **Wake On Ring**

This option allow user to determine the action of the system power is off and the modem is ringing.

- ▶▶ Enabled Enable Wake On Ring. (Default setting)
- ▶▶ Disabled Disable this function.

Note: This item must enabled if you're running under Windows operating system.

☞ **Wake On RTC Alarm**

When "RTC Alarm Resume" item is set to enabled, system will wakeup from RTC. (This item will be functionalized under ACPI OS)

- ▶▶ Enabled Enable alarm function to POWER ON system. (Default setting)
- ▶▶ Disabled Disable this function.

Note: This item must enabled if you're running under Windows operating system.

Hardware Monitor

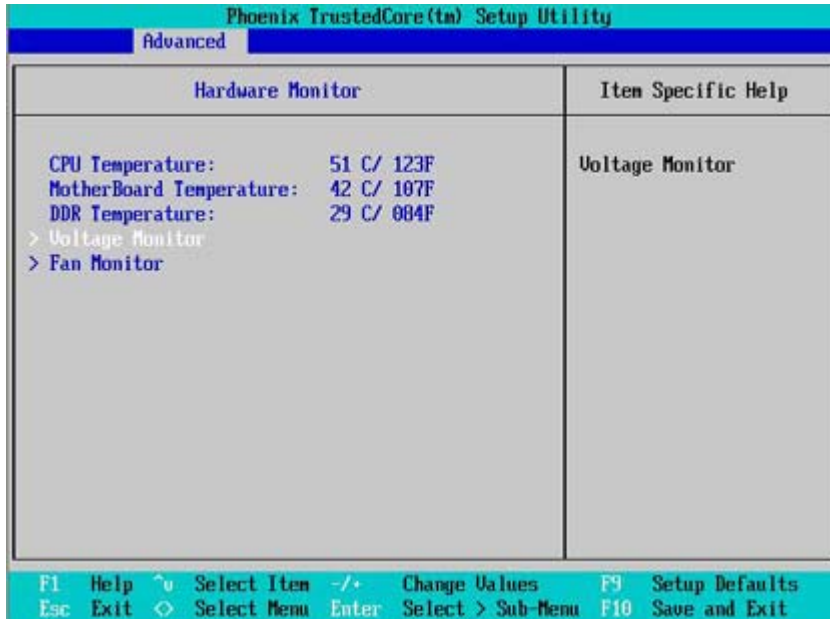

Figure 2-5: Hardware Monitor

☞ CPU/Motherboard/DDR Temperature

▶▶ Display the current CPU temperature, Motherboard, and Ambient temperature.

☞ Voltage Monitor: DDR1V8, VCC3V3, VCORE, 12V2, 5V

▶▶ Detect system's voltage status automatically.

☞ FAN Monitor: CPU Fan/System Fan/Front Fan/Rear Fan (RPM)

▶▶ Display the current CPU and system fAN speed.

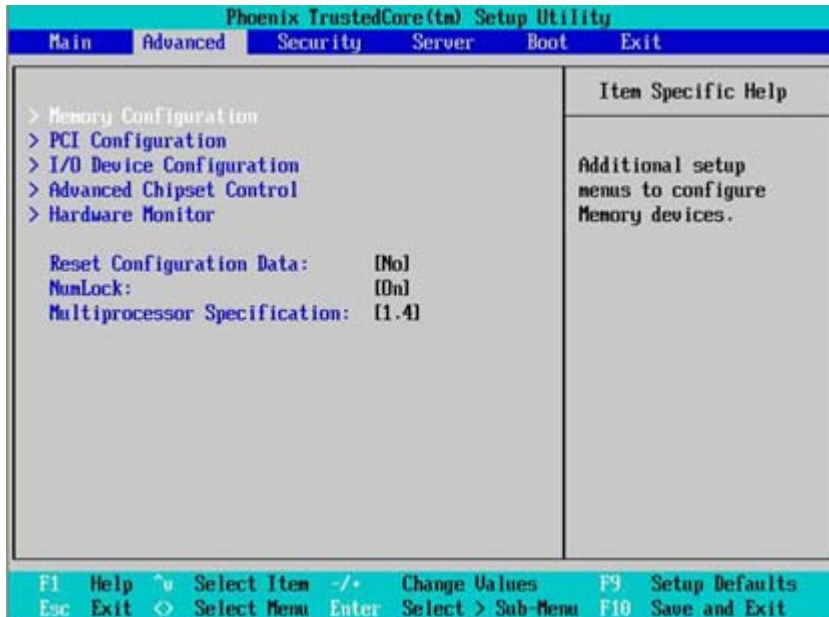

☞ Reset Configuration Data

- ▶▶ Yes Reset all configuration data.
- ▶▶ No Do not make any changes. (Default setting)

☞ NumLock

This option allows user to select power-on state for NumLock.

- ▶▶ On Enable NumLock. (Default setting)
- ▶▶ Off Disable this function.

☞ Multiprocessor Specification

This option allows user to configure the multiprocessor(MP) specification revision level. Some operating system will require 1.1 for compatibility reasons.

- ▶▶ 1.4 Support MPS Version 1.4 . (Default setting)
- ▶▶ 1.1 Support M PS Version 1.1.

Security

🔗 About This Section: Security

In this section, user can set either supervisor or user passwords, or both for different level of password securities. In addition, user also can set the virus protection for boot sector.

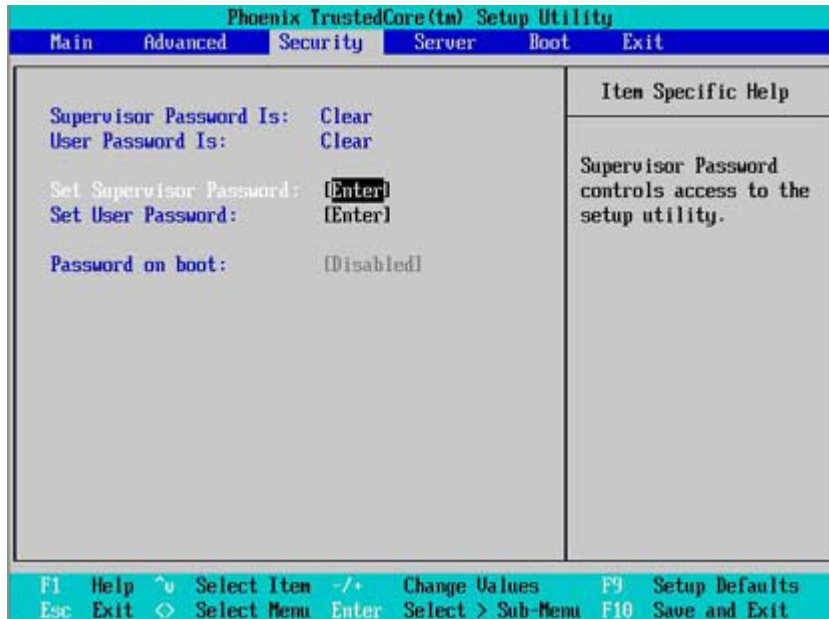

Figure 3: Security

🔗 Set User Password

You can only enter but do not have the right to change the options of the setup menus. When you select this function, the following message will appear at the center of the screen to assist you in creating a password.

Type the password up to 6 characters in length and press <Enter>. The password typed now will clear any previously entered password from the CMOS memory. You will be asked to confirm the entered password. Type the password again and press <Enter>. You may also press <Esc> to abort the selection and not enter a specified password.

☞ **Set Supervisor Password**

You can install and change this options for the setup menus. Type the password up to 6 characters in length and press <Enter>. The password typed now will clear any previously entered password from the CMOS memory. You will be asked to confirm the entered password. Type the password again and press <Enter>. You may also press <Esc> to abort the selection and not enter a specified password or press <Enter> key to disable this option.

☞ **Password on boot**

Password entering will be required when system on boot.

- ▶▶ Enabled Requires entering password when system on boot.
- ▶▶ Disabled Disable this function. (Default setting)

Server

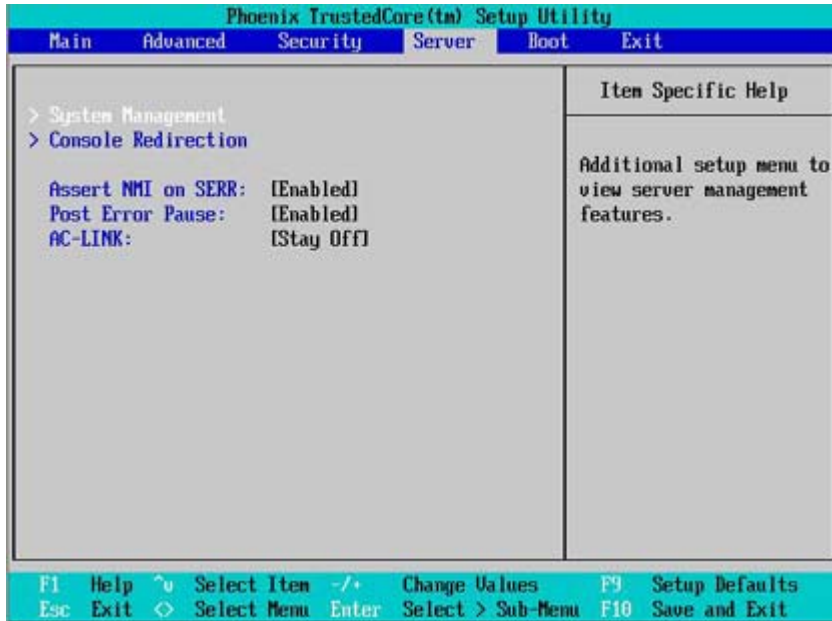

Figure 4: Server

System Management

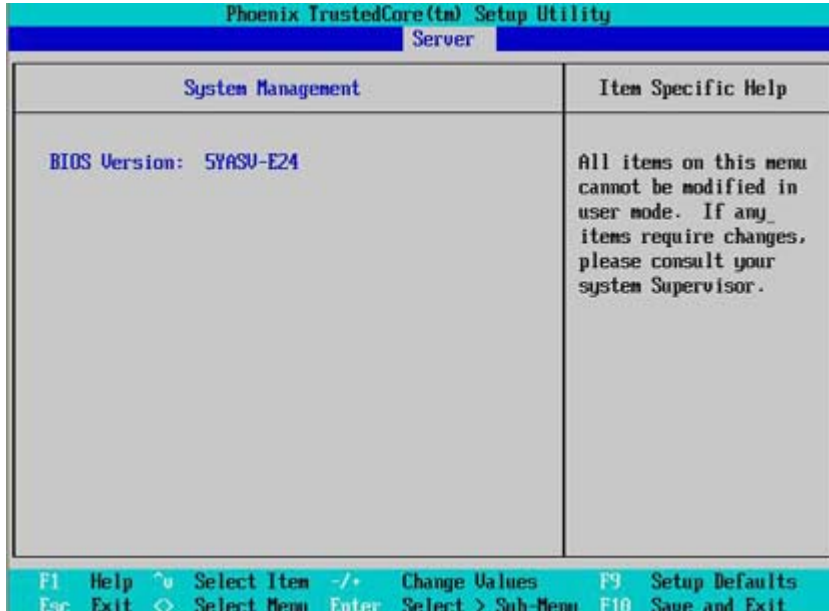

Figure 4-1: System Management

Server Management

This category allows user to view the server management features. Including information of **BIOS Version**. All items in this menu cannot be modified in user's mode. If any items require changes, please consult your system supervisor.

Console Redirection

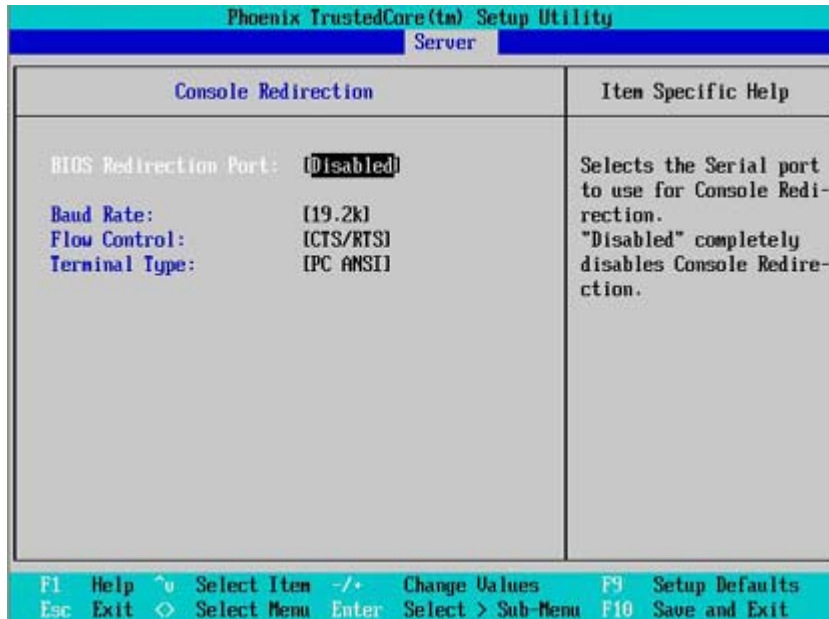

Figure 4-2: Console Redirection

☞ BIOS Redirection Port

If this option is set to enabled, it will use a port on the motherboard.

- ▶▶ Serial Port A Use Serial Port as the COMA port address.
- ▶▶ Serial Port B Use Serial Port as the COMB port address.
- ▶▶ Disabled Disable this function. (Default setting)

Note: Tower has COMA and COMB.

☞ Baud Rate

This option allows user to set the specified baud rate.

- ▶▶ Options 300, 1200, 2400, 9600, 19.2K, 38.4K, 57.6K, 115.2K.

☞ **Flow Control**

This option provide user to enable the flow control function.

- ▶▶ None Not supported.
- ▶▶ XON/OFF Software control.
- ▶▶ CTS/RTS Hardware control. (Default setting)

☞ **Terminal Type**

This option allows user to select the specified terminal type. This is defined by IEEE.

- ▶▶ Options VT100, VT100 8bit, PC-ANSI 7bit, VT100+, VT-UTF8.

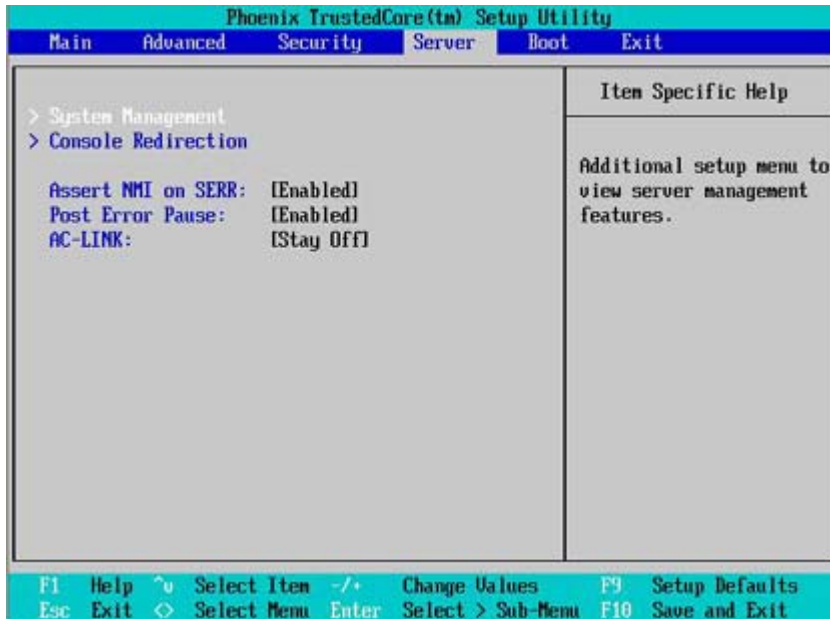

☞ Assert NMI on SERR

If this option is set to enabled, PCI bus system error (SERR) is enabled and is routed to NMI.

- ▶▶ Enabled Enable Assert NMI on SERR. (Default setting)
- ▶▶ Disabled Disable this function.

☞ Post Error Pause

If this item is set to enabled, the system will wait for user intervention on critical POST errors.

If this item is disabled, the system will boot with no intervention if possible.

- ▶▶ Enabled Enable Post Error Pause. (Default setting)
- ▶▶ Disabled Disable this function.

AC-LINK

This option provides user to set the mode of operation if an AC / power loss occurs.

- ▶▶ Power On System power state when AC cord is re-plugged.
- ▶▶ Stay Off Do not power on system when AC power is back.
- ▶▶ Last State Set system to the last state when AC power is removed. Do not power on system when AC power is back. (Default setting)

Boot

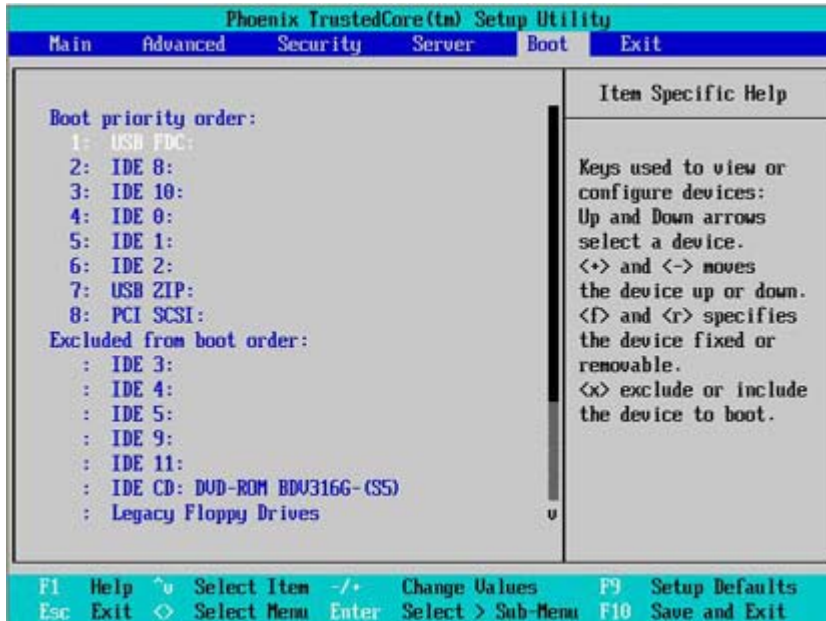

Figure 5: Boot

☞ Boot Priority Order

This field determines which type of device the system attempt to boot from after PhoenixBIOS Post completed. Specifies the boot sequence from the available devices. If the first device is not a bootable device, the system will seek for next available device.

Key used to view or configure devices:

Up and Down arrows select a device.

<+> and <-> moves the device up or down.

<f> and <r> specifies the device fixed or removable.

<x> exclude or include the device to boot.

<1-4> Loads default boot sequence.

Exit

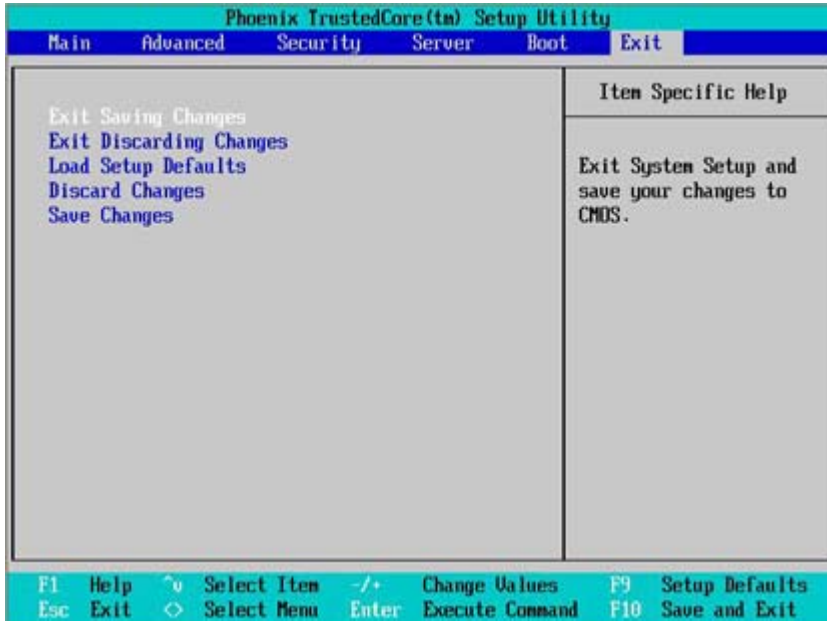

Figure 6: Exit

⚡ About This Section: Exit

Once you have changed all of the set values in the BIOS setup, you should save your changes and exit BIOS setup program. Select "Exit" from the menu bar, to display the following sub-menu.

- ☛ Exit Saving Changes
- ☛ Exit Discarding Changes
- ☛ Load Setup Defaults
- ☛ Discard Change
- ☛ Save Changes

☞ Exit Saving Changes

This option allows user to exit system setup with saving the changes.

Press <Enter> on this item to ask for the following confirmation message:

Pressing 'Y' to store all the present setting values tha user made in this time into CMOS.

Therefore, whenyou boot up your computer next time, the BIOS will re-configure your system according data in CMOS.

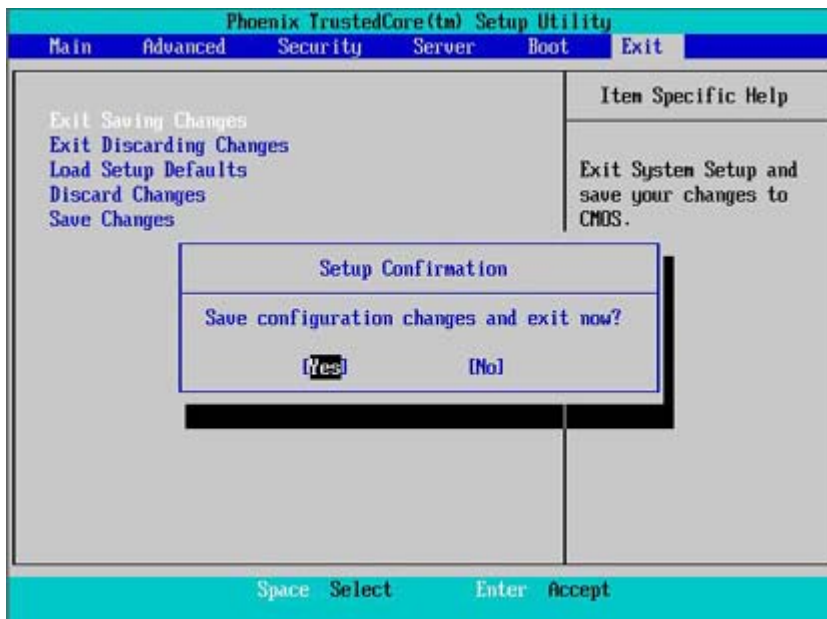

☞ Exit Discarding Changes

This option allows user to exit system setup without changing any previous settings values in CMOS. The previous selection remain in effect. This will exit the Setup Utility and restart your computer when selecting this option.

☞ Load Setup Default

This option allows user to load default values for all setup items. When you press <Enter> on this item, you will get a confirmation dialog box with a message as below:

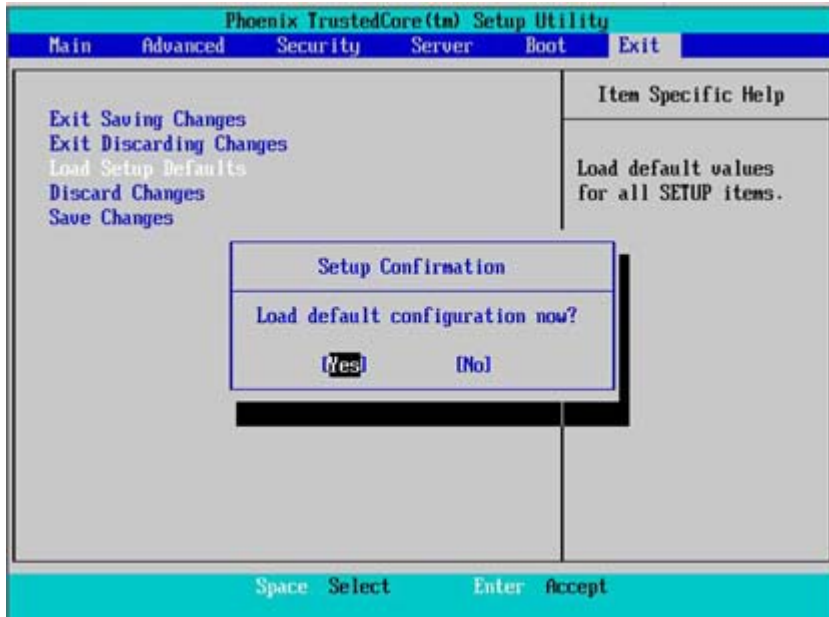

☞ Discard Changes

This option allows user to load previous values from CMOS for all setup item.

When you press <Enter> on this item, you will get a confirmation dialog box with a message as below:



☞ Save Changes

This option allows user to save setup data to CMOS.

When you press <Enter> on this item, you will get a confirmation dialog box with a message as below:

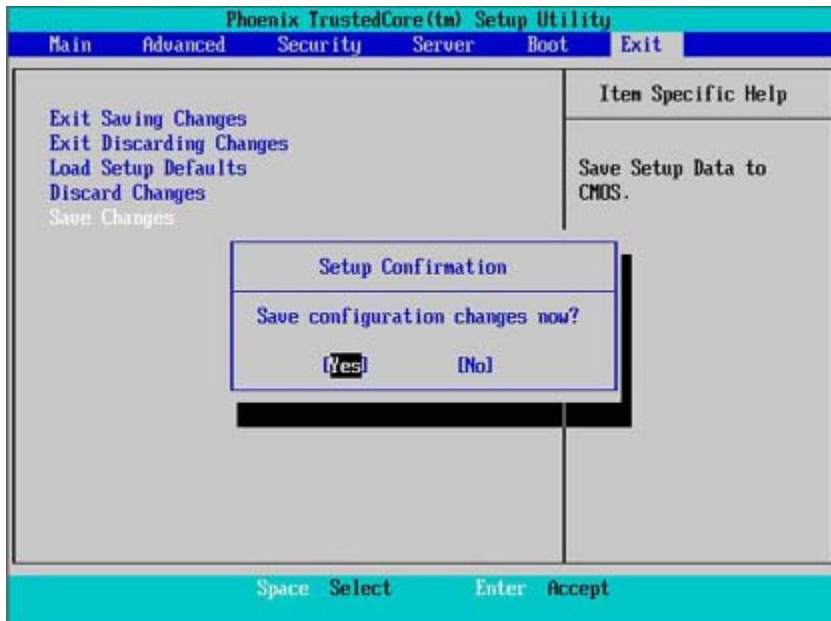

Press [Yes] to save setup data to CMOS.

Chapter 4 INTEL RAID BIOS Configuration

Configuring the Intel RAID BIOS

The Intel RAID BIOS setup lets you choose the RAID array type and which hard drives you want to make part of the array.

Entering the RAID BIOS Setup

1. After rebooting your computer, wait until you see the RAID software prompting you to press Ctrl + I. The RAID prompt appears as part of the system POST and boot process prior to loading the OS. You have a few seconds to press Ctrl + I before the window disappears.

```
Intel(R) Matrix Storage Manager option ROM V5.0.0.1011 ICH7R wRAID5
Copyright(C) 2003-04 Intel Corporation. All Rights Reserved.

RAID Volumes :
None Defined.

Physical Disks :
Port   Driver Model   Serial #           Size   Type/Status(Vol ID)
0      ST3120026AS    3JT354CP          111.7GB Non-RAID Disk
1      ST3120026AS    3JT329JX          111.7GB Non-RAID Disk

Press <CTRL - I> to enter Configuration Utility
```

Press Ctrl + I. The Intel RAID Utility - Create RAID Volume window appears (as illustrated below).

```
Intel(R) Matrix Storage Manager option ROM V5.0.0.1011 ICH7R wRAID5
Copyright(C) 2003-04 Intel Corporation. All Rights Reserved.

[ MAIN MENU ]
1. Create RAID Volume
2. Delete RAID Volume
3. Reset Disks to Non-RAID
4. Exit

[ DISK/VOLUME INFORMATION ]

RAID Volumes :
None Defined.

Physical Disks :
Port   Driver Model   Serial #           Size   Type/Status(Vol ID)
0      ST3120026AS    3JT329JX          111.7GB Non-RAID Disk
1      ST3120026AS    3JT354CP          111.7GB Non-RAID Disk

[↑↓]-Select      [ESC]-Exit      [ENTER]-Select Menu
```

Create RAID Volume

Press **Enter** under **Create RAID Volume** to set up RAID.

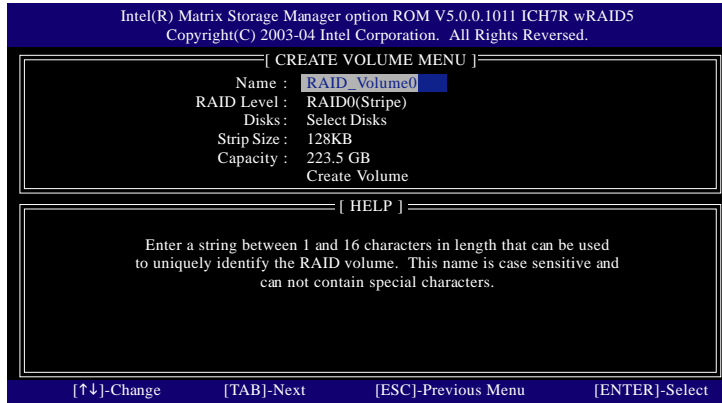

After entering the Create Volume Menu, you can set disk name with 1-16 letters (letters cannot be special characters) under **Name** item.

After setting disk name, press **Enter** to select **RAID Level**.

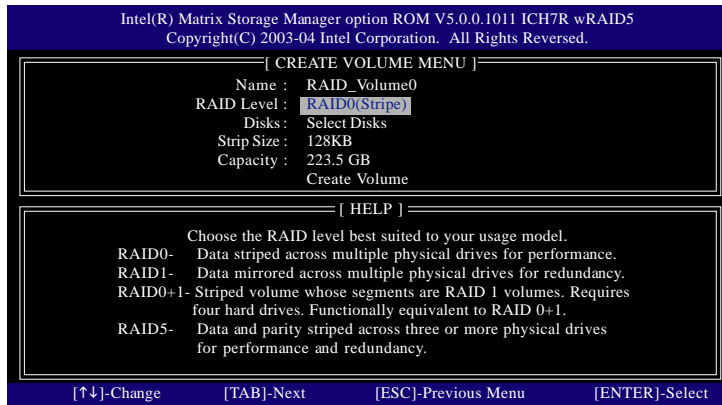

There are four RAID levels: RAID0(Stripe), RAID1(Mirror), RAID 0+1 (Striping + Mirroring) and RAID5. After selecting the RAID level, press **Enter** to select **Strip Size**.

The KB is a unit of Strip Size. You can set disk block size with this item.

The disk block size can be set from 4KB to 128KB. After you set disk block size, press **Enter** to set disk **Capacity**.

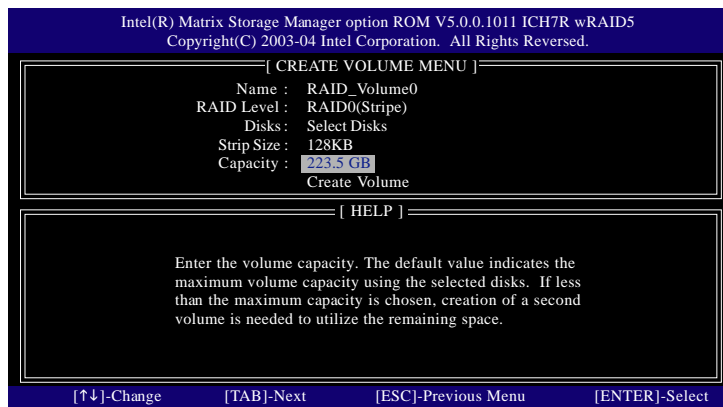
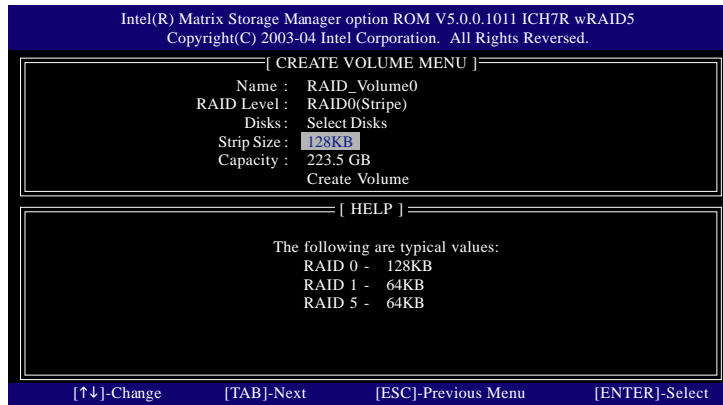

Press **Enter** to enter **Create Volume** after setting disk capacity.

Press Enter under the Create Volume item.

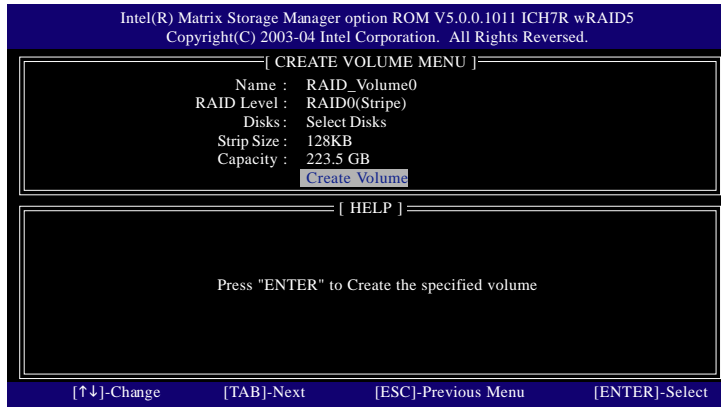

An alert bar will be displayed warning you that all data on selected disks will be lost. Please press Y to complete the set-up of RAID.

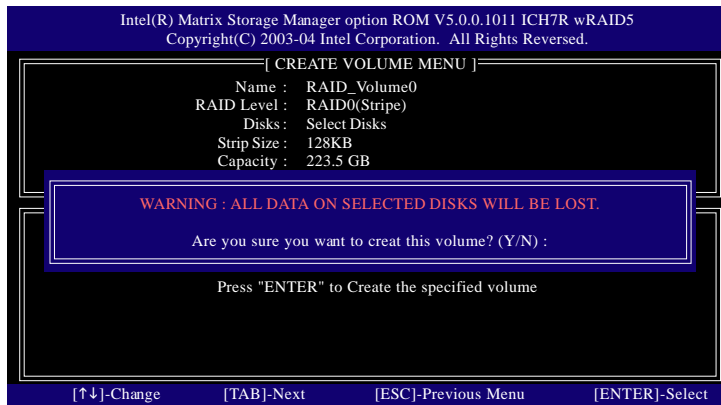

After the completion, you will see the detailed information about the RAID, such as RAID level, disk block size, disk name and disk capacity, etc.

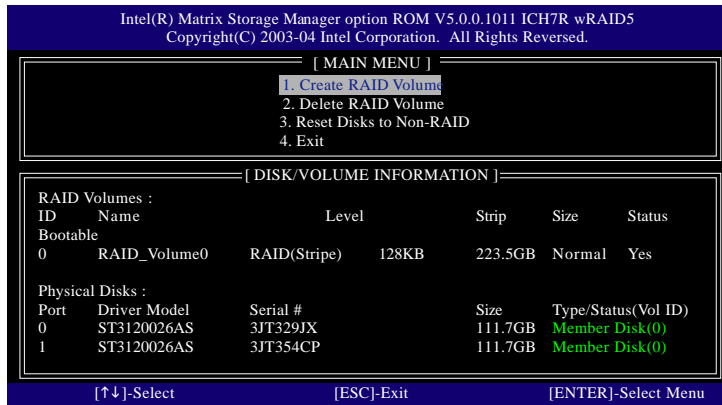

Delete RAID Volume

If you want to delete a RAID volume, please select the **Delete RAID Volume** option. Press **Enter** key and follow the instructions on the screen.

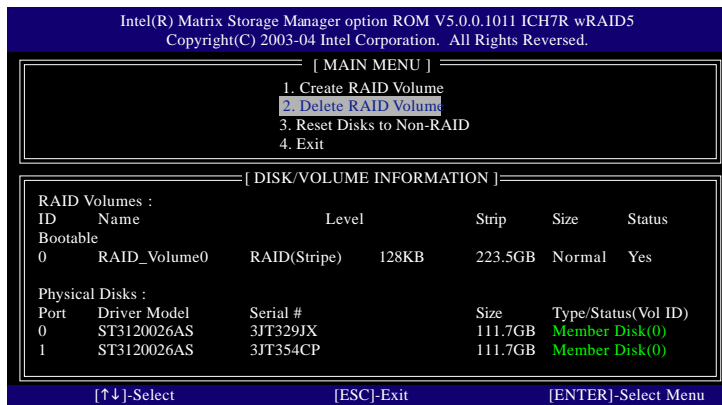

Chapter 5 Appendix

Appendix : Acronyms

Acronyms	Meaning
ACPI	Advanced Configuration and Power Interface
APM	Advanced Power Management
AGP	Accelerated Graphics Port
AMR	Audio Modem Riser
ACR	Advanced Communications Riser
BBS	BIOS Boot Specification
BIOS	Basic Input / Output System
CPU	Central Processing Unit
CMOS	Complementary Metal Oxide Semiconductor
CRIMM	Continuity RIMM
CNR	Communication and Networking Riser
DMA	Direct Memory Access
DMI	Desktop Management Interface
DIMM	Dual Inline Memory Module
DRM	Dual Retention Mechanism
DRAM	Dynamic Random Access Memory
DDR	Double Data Rate
ECP	Extended Capabilities Port
ESCD	Extended System Configuration Data
ECC	Error Checking and Correcting
EMC	Electromagnetic Compatibility
EPP	Enhanced Parallel Port
ESD	Electrostatic Discharge
FDD	Floppy Disk Device
FSB	Front Side Bus
HDD	Hard Disk Device
IDE	Integrated Dual Channel Enhanced
IRQ	Interrupt Request

to be continued.....

Acronyms	Meaning
I/O	Input / Output
IOAPIC	Input Output Advanced Programmable Input Controller
ISA	Industry Standard Architecture
LAN	Local Area Network
LBA	Logical Block Addressing
LED	Light Emitting Diode
MHz	Megahertz
MIDI	Musical Instrument Digital Interface
MTH	Memory Translator Hub
MPT	Memory Protocol Translator
NIC	Network Interface Card
OS	Operating System
OEM	Original Equipment Manufacturer
PAC	PCI A.G.P. Controller
POST	Power-On Self Test
PCI	Peripheral Component Interconnect
RIMM	Rambus in-line Memory Module
SCI	Special Circumstance Instructions
SECC	Single Edge Contact Cartridge
SRAM	Static Random Access Memory
SMP	Symmetric Multi-Processing
SMI	System Management Interrupt
USB	Universal Serial Bus
VID	Voltage ID
